

**TUGAS WAJIB**  
**STRUKTUR BAJA**

**Disusun Oleh:**

**YUDHA SEPTIAWAN LUBIS**

**14-811-0059**



**PROGRAM STUDI TEKNIK SIPIL**

**FAKULTAS TEKNIK**

**UNIVERSITAS MEDAN AREA**

**MEDAN**

**2020**

**TUGAS WAJIB**  
**STRUKTUR BAJA**

**Disusun Oleh:**

**YUDHA SEPTIAWAN LUBIS**

**14-811-0059**



**PROGRAM STUDI TEKNIK SIPIL**

**FAKULTAS TEKNIK**

**UNIVERSITAS MEDAN AREA**

**MEDAN**

**2020**

**LEMBAR PENGESAHAN**

**TUGAS WAJIB**  
**STRUKTUR BAJA**

Disusun Oleh:

**YUDHA SEPTIAWAN LUBIS**

**14.811.0059**

**Disetujui Oleh:**

**Kaprodi Teknik Sipil**

**Dosen Pengampu**

**Ir. Kamaluddin Lubis, MT.**

**Ir. H. Edy Hermanto, MT**



FAKULTAS TEKNIK  
PROGRAM STUDI TEKNIK SIPIL  
UNIVERSITAS MEDAN AREA

Jalan Kolam No. 1 Medan Estate Medan

Nomor : Medan, 17-3 20.17  
Lamp :  
Hal : Pembimbing tugas wajib

Kepada : Yth, Bapak : *Ir. H. Eng. Heriawan MT*  
Staf Pengajar Program Studi Jurusan Sipil  
Universitas Medan Area  
Di Medan,-

Dengan hormat,

Sehubungan dengan mahasiswa yang tersebut namanya dibawah ini:

Nama : *Yudha Septiawan Lubis*  
Stambuk : *14.01.0059*  
Tk/Jurusan : *Teknik Sipil*

Telah memenuhi syarat mengambil tugas wajib : *Bayu*  
yang merupakan salah satu persyaratan sidang sarjana di Jurusan sipil,  
maka dengan ini kami mohon kesediaan Bapak, untuk dapat membimbing  
mahasiswa tersebut diatas .

Demikianlah kami sampaikan atas perhatian dan kerja sama yang baik  
kami ucapkan terima kasih.

Hormat kami,

Ketua Prodi Jurusan Sipil

*[Signature]*  
Ir. Muhammad Lubis.MT

Tembusan: Peninggal

1/08/20

JURUSAN TEKNIK SIPIL  
FAKULTAS TEKNIK  
UNIVERSITAS MEDAN AREA

TUGAS BAJA

Diberikan kepada :

Nama :

NPM :

Diketahui :

- Bentang ..... L = m
- Tinggi ..... H1 = m
- Jarak Gading-gading Kap ..... l = 2a m
- Jenis Atap ..... *S* =
- Mutu Baja ..... *S137* =

Ditanya :

- Dimensionering gording dalam 3 variasi
- Daftar gaya-gaya batang
- Dimensionering batang profil dan detail
- Daftar kontrol bahan untuk berat sendiri

\* *Date: for trial only*

A).

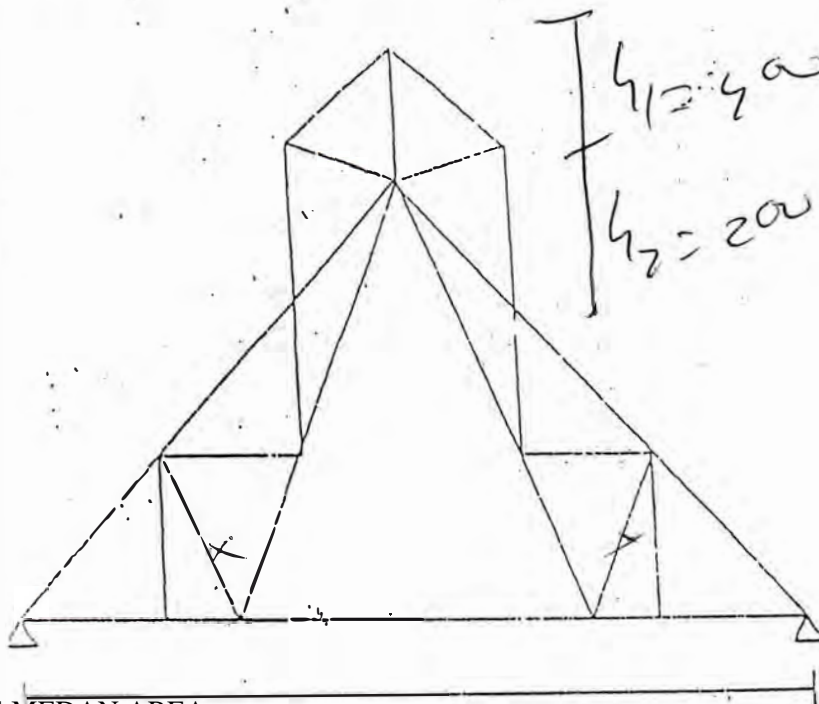

JURUSAN TEKNIK SIPIL  
 FAKULTAS TEKNIK  
 UNIVERSITAS MEDAN AREA

B).

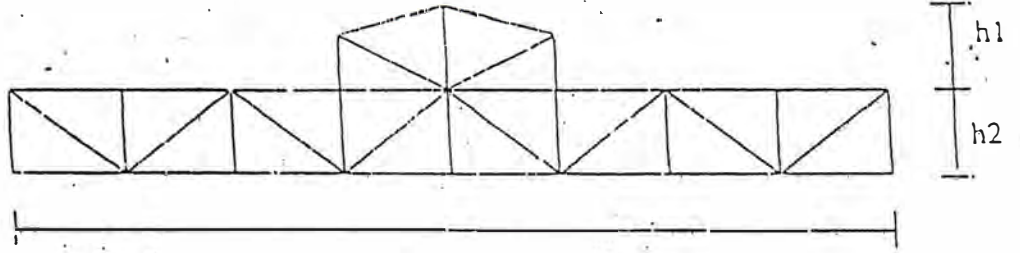

C).

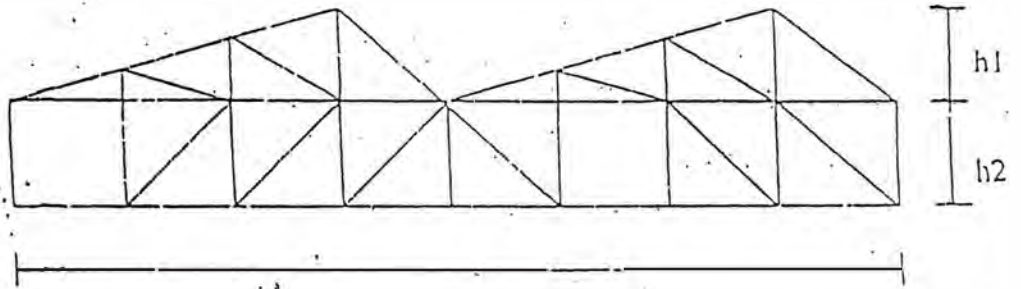



Medan, Nopember 20  
 Dosen Pengasuh,

*[Handwritten signature]*  
 20  
 03  
 Dr. H. Em. H. H. H. H. H.

DAFTAR ASISTENSI TUGAS STRUKTUR BAJA II

NAMA : Yudha Septiawan Lubis

NPM : 148110059

NO	TANGGAL	KETERANGAN	TANDA TANGAN
1	17/06-17	layutan	
2	11/07-12	layutan	
	17/11	layutan / jilid	

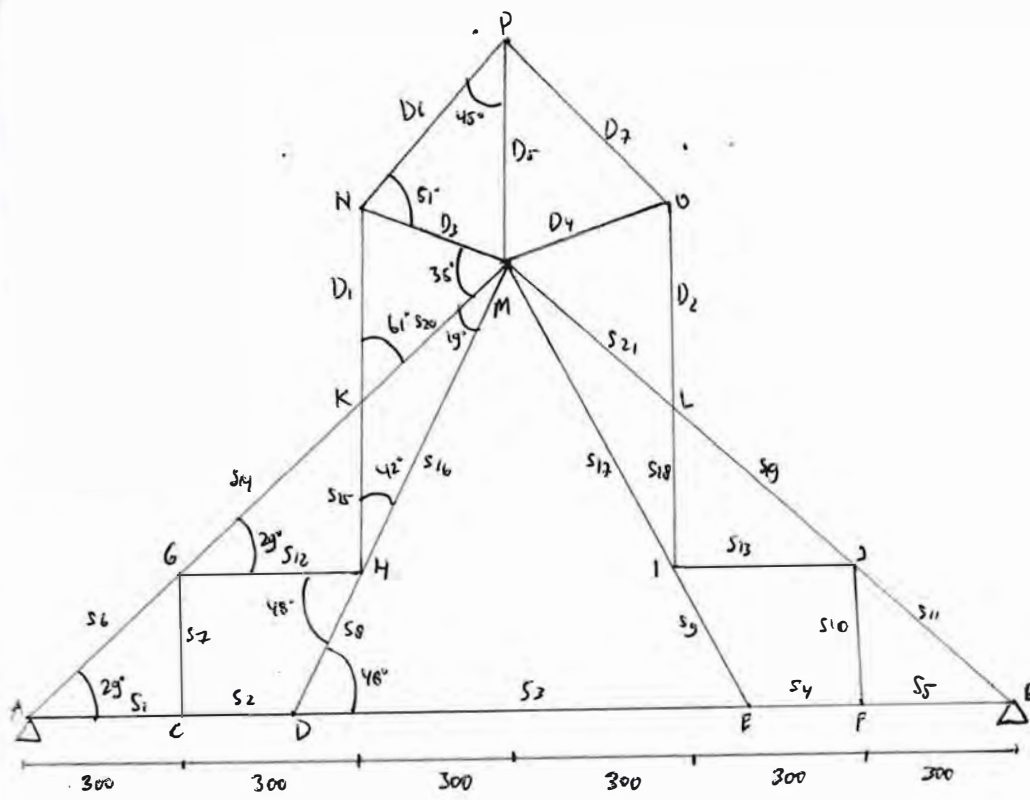

Diketahui

- 1. Bentang (L) = 12 meter
- 2. tinggi (H) = 8 meter
- konstruksi A = 3 meter
- konstruksi B = 5 meter

3. Jarak gading = kap = 3 meter

4. Jenis Atap = Seng

5. mutu baja = B37

6. Panjang masing-masing rangka Batang :

- $D_1 = 2 \text{ m}$                        $D_5 = 3,33 \text{ m}$
- $D_2 = 2 \text{ m}$                           $D_6 = 4,24 \text{ m}$
- $D_3 = 3,02 \text{ m}$                       $D_7 = 4,24 \text{ m}$
- $D_4 = 3,02 \text{ m}$

$S_1 = 3 \text{ m}$        $S_6 = 3,43 \text{ m}$        $S_{11} = 3,43 \text{ m}$        $S_{16} = 4,48 \text{ m}$        $S_{21} = 3,43 \text{ m}$

$S_2 = 1,5 \text{ m}$        $S_7 = 1,64 \text{ m}$        $S_{12} = 3 \text{ m}$        $S_{17} = 4,48 \text{ m}$

UNIVERSITAS MEDAN-AREA       $S_3 = 9 \text{ m}$        $S_8 = 2,74 \text{ m}$        $S_{13} = 3 \text{ m}$        $S_{18} = 2,33 \text{ m}$

$S_4 = 2,24 \text{ m}$        $S_{14} = 3,11 \text{ m}$        $S_{19} = 2,11 \text{ m}$



## 7 Sudut

$$\sin 29 = 0,48$$

$$\cos 29 = 0,87$$

$$\sin 6^\circ = 0,10$$

$$\cos 6^\circ = 0,99$$

$$\sin 84 = 0,99$$

$$\cos 84 = 0,16$$

$$\sin 48 = 0,71$$

$$\cos 48 = 0,66$$

$$\sin 45 = 0,707$$

$$\cos 45 = 0,707$$

$$\sin 90 = 1$$

$$\cos 90 = 0$$

$$\sin 19 = 0,33$$

$$\cos 19 = 0,98$$

$$\sin 35 = 0,57$$

$$\cos 35 = 0,81$$

## Dimensi

1. Dimensi gording dlm 3 variasi
2. Daftar Jaga = Batang
3. dimensi batang profil dan daki
- = Daftar Kontrol bahan Unsur berat sendiri

## Perhitungan beban

Panjang masing: Panjang Batang

$$D_1 = 2$$

$$D_2 = 2$$

$$D_3 = 3,02$$

$$D_4 = 3,02$$

$$D_5 = 3,33$$

$$D_6 = 4,24$$

$$D_7 = 4,24$$

$$D_8 = 3,43$$

$$D_9 = 3,43$$

an mati

$$\text{Atap} = 8,48 \times 5 \times 10 = 424 \text{ kg}$$

$$\text{Pengikat atap} = 1 \text{ kg}$$

$$\text{Ventilasi} = 20 \times 20,5 = 410 \text{ kg}$$

$$\text{Gording} = 5 \times 4,76 \times 13 \text{ bh} = 309,4 \text{ kg}$$

$$\text{Pengikat gording} = 1 \text{ kg}$$

$$\text{Tiang Atap (L.65.65.7)} = 28,71 \times 6,83 \text{ kg/m} = 196,64 \text{ kg}$$

$$\text{Total beban mati} = 1342,04 \text{ kg}$$

$$\text{Beban } P_1 = 312,04 \text{ kg}$$

$$P_{2a} = 515 \text{ kg}$$

$$P_{2b} = 515 \text{ kg}$$

- Beban hidup

$$\text{Beban } P_{1a} = 100 \text{ kg}$$

$$P_{2a} = 100 \text{ kg}$$

$$P_{2b} = 100 \text{ kg}$$

---

$$300 \text{ kg}$$

Beban Angin

Data Atap:

$$\text{Jarak gording (L)} = 1$$

$$\text{Kemiringan } (\alpha) = 20$$

$$\text{Besarnya beban angin (W)} = 25 \text{ kg/m}^2$$

- Koef. angin tekan

- Pada bidang tidak ada angin

UNIVERSITAS MEDAN AREA

$$W_p = C \times L \times W$$

$$W_{da} = (C \times \alpha - 0,4) \times L \times W$$

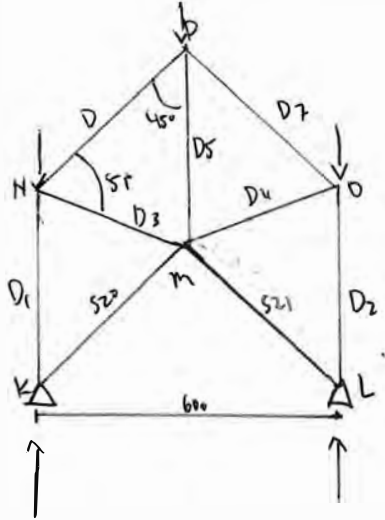

Perhitungan REAKSI

$\sum M_K = 0$

$$= R_{LV} \times 6 - P_2 \times 6 - P_1 \times 3 - P_2 \times 0$$

$$= R_{LV} \times 6 - 515 \times 6 - 312,04 \times 3 - 515 \times 0$$

$R_{LV} = 358,98 \text{ kg}$

$\sum M_L = 0$

$$= R_{UV} \times 6 - P_2 \times 6 - P_1 \times 3 - P_2 \times 0$$

$$= R_{UV} \times 6 - 515 \times 6 - 312,04 \times 3 - 515 \times 0$$

$R_{UV} = 358,98 \text{ kg}$

Reaksi K

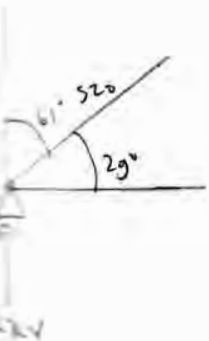

$\sum H = 0$

$S_{20} = 0$

$\sum V = 0$

$R_{KV} + D_1 + S_{20} \times \sin 29^\circ = 0$

$358,98 + D_1 + 0,40 \times 0 = 0$

$D_1 = -358,98 \text{ kg (Tekan)}$

Reaksi L

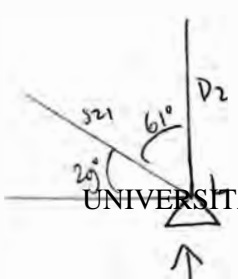

$\sum H = 0$

$S_{21} = 0$

$R_{LV} + D_2 + S_{21} \times \sin 29^\circ = 0$

Buhol N

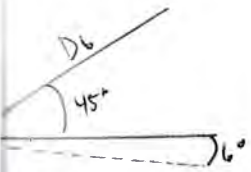

$$\sum V = 0$$

$$D_1 - P_{2a} + D_6 \times \sin 45^\circ + D_3 \times \sin 6^\circ = 0$$

$$-358,98 - 515 + 56 \times \sin 45^\circ + D_3 \times \sin 6^\circ = 0$$

$$-873,98 + 0,707 \times D_6 + 0,10 \times D_3 = 0 \dots (1)$$

$$\sum H = 0$$

$$D_6 \times \cos 45^\circ + D_3 \times \cos 6^\circ = 0$$

$$0,707 \times D_6 + 0,99 \times D_3 = 0$$

$$D_6 = -1,4 \times D_3 \dots (2)$$

Pers 1

$$-873,98 + (0,707 \times (-1,4) \times D_3 + 0,10 \times D_3 = 0$$

$$-873,98 - 0,99 \times D_3 + 0,10 \times D_3 = 0$$

$$-873,98 - 0,89 \times D_3 = 0$$

$$D_3 = -982 \text{ kg (tekan)}$$

Dari hasil diatas, maka diperoleh

$$D_6 = -1,4 \times D_3$$

$$= -1,4 \times -982$$

$$D_6 = 1374,8 \text{ kg (tarik)}$$

Buhol 0

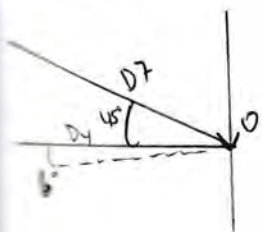

$$\sum V = 0$$

$$D_2 - P_{2b} + D_7 \times \sin 45^\circ + D_4 \times \sin 6^\circ = 0$$

$$-358,98 - 515 + D_7 \times \sin 45^\circ + D_4 \times \sin 6^\circ = 0$$

$$-873,98 + 0,707 \times D_7 + 0,10 \times D_4 = 0 \dots (1)$$

$$\sum H = 0$$

$$D_7 \times \cos 45^\circ + D_4 \times \cos 6^\circ = 0$$

$$0,707 \times D_7 + 0,99 \times D_4 = 0$$

$$D_7 = -1,4 \times D_4 \dots (2)$$

Pers 2 disubstitusikan ke Pers 1

UNIVERSITAS MEDAN AREA

$$-873,98 + (0,707 \times (-1,4) \times D_4 + 0,10 \times D_4 = 0$$

$$D_4 = -982 \text{ kg (tekan)}$$

Dari hasil diatas, maka diperoleh

$$D7 = -1,4 \times D4$$

$$= -1,4 \times 982$$

$$D7 = 1374,8 \text{ kg (Tarik)}$$

Titik Buhul P

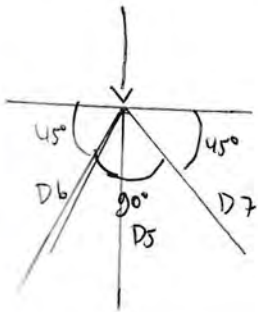

$$\sum V = 0$$

$$D6 \times \sin 45^\circ - P + D7 \times \sin 45^\circ + D5 = 0$$

$$1374,8 \times 0,707 - 312,04 + 1374,8 \times 0,707 + D5 = 0$$

$$D5 = 312,04 \text{ kg (tarik)}$$

$$\sum H = 0$$

$$D6 \times \cos 45^\circ + D7 \times \cos 45^\circ = 0$$

$$0,707 \times D7 + 0,707 \times D6 = 0$$

$$D7 = -D6$$

No Batang	Batang Tarik (+)	Batang Tekan
D1	-	-358,98
D2	-	-358,98
D3	982	-
D4	982	-
D5	-	312,04
D6	-	1374,8
D7	-	1374,8
S20	-	-
S21	-	-

## Perhitungan Gaya batang Beban hidup

Perhitungan reaksi

$$\sum M_K = 0$$

$$= R_{LV} \times 6 - P_{2b} \times 6 - P_1 \times 3 - P_{2a} \times 0$$

$$R_{LV} \times 6 - 100 \times 6 - 100 \times 3 - 100 \times 0$$

$$R_{LV} = 150 \text{ kg}$$

$$\sum M_L = 0$$

$$= R_{LV} \times 6 - P_{2a} \times 6 - P_1 \times 3 - P_{2b} \times 0$$

$$= R_{LV} \times 6 - 100 \times 6 - 100 \times 3 - 1 \times 0$$

$$R_{LV} = 150 \text{ kg}$$

- Perhitungan Gaya batang

Titik buhul K

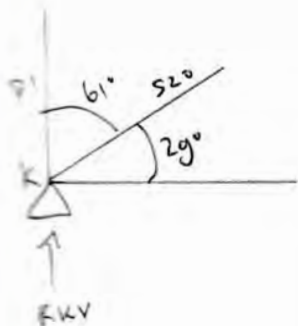

$$\sum H = 0$$

$$S_{20} = 0$$

$$\sum V = 0$$

$$R_{KV} + D_1 S_{20} \times \sin 29^\circ = 0$$

$$150 + D_1 + 0,48 \times 0 = 0$$

$$D_1 = -150 \text{ kg (Tension)}$$

Titik Buhul N

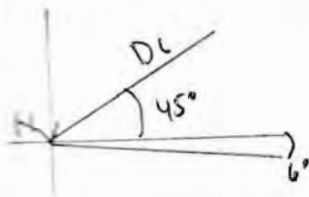

$$\sum V = 0$$

$$D_1 - P_{2a} + D_6 \times \sin 45^\circ + D_3 \times \sin 6^\circ = 0$$

$$-150 - 100 + D_6 \sin 45^\circ + D_3 \sin 6^\circ = 0$$

$$-250 + 0,707 \times D_6 + 0,10 \times D_3 = 0 \dots (1)$$

$$\sum H = 0$$

$$D_6 \times \cos 45^\circ + D_3 \times \cos 6^\circ = 0$$

$$0,707 \times D_6 + 0,99 \times D_3 = 0$$

$$D_6 = -1,4 \times D_3 \dots (2)$$

$$-250 + 0,707 \times (-1,4) \times D_3 + 0,10 \times D_3 = 0$$

Dari hasil diatas, mana diperoleh

$$D_6 = -1,4 \times D_3$$

$$= -1,4 \times -280,90$$

$$D_6 = 393,26 \text{ kg (Tarik)}$$

Titik buhul O

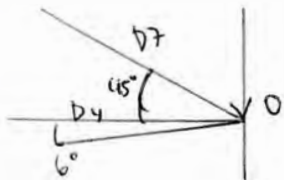

$$\sum V = 0$$

$$D_2 - P_2b + D_7 \times \sin 45^\circ + D_4 \times \sin 6^\circ = 0$$

$$-150 - 100 + D_7 \sin 45^\circ + D_4 \times \sin 6^\circ = 0$$

$$-250 + 0,707 \times D_7 + 0,10 \times D_4 = 0 \dots (1)$$

$$\sum H = 0$$

$$D_7 \times \cos 45^\circ + D_4 \times \cos 6^\circ = 0$$

$$0,707 \times D_7 + 0,99 \times D_4 = 0$$

$$D_7 = -1,4 \times D_4 \dots (2)$$

Pers 2 disubstitusikan ke pers 1

$$-250 + (0,707 \times (-1,4) \times D_4 + 0,10 \times D_4 = 0$$

$$-250 - 0,99 \times D_4 + 0,10 \times D_4 = 0$$

$$-250 - 0,89 \times D_4 = 0$$

$$D_4 = -280,90 \text{ kg (Tekan)}$$

Dari hasil diatas, diperoleh

$$D_7 = -1,4 \times D_4$$

$$= -1,4 \times -280,90$$

$$D_7 = 393,26 \text{ (Tarik)}$$

Titik Buhul P

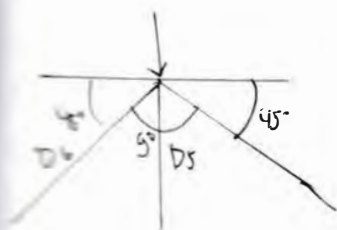

$$\sum V = 0$$

$$D_6 \times \sin 45^\circ - P_1 + D_7 \sin 45^\circ + D_5 = 0$$

$$393,26 \times 0,707 + 100 + 393,26 \times 0,707 + D_5 = 0$$

$$D_5 = 100 \text{ kg (Tarik)}$$

$$\sum H = 0$$

$$D_6 \cos 45^\circ + D_7 \times \cos 45^\circ = 0$$

$$0,707 \times D_6 + 0,707 \times D_7 = 0$$

# TUGAS WAJIB STRUKTUR BAJA

---

**TABEL GAYA BATANG**

PERHITUNGAN GAYA BATANG (BEBAN HIDUP)		
No Batang	Batang Tarik (+)	Batang Tekan (-)
D1	-	-150
D2	-	-150
D3	280.9	-
D4	280.9	-
D5	-	100
D6	-	393.26
D7	-	393.26
S20	-	-
S21	-	-



## Perhitungan Gaya Batang Deban angin Datang

$$w_{da} = 4,5 \text{ kg/m}$$

$$w_{da} \cos 45^\circ = 3,18 \text{ kg/m}$$

$$w_{da} \sin 45^\circ = 3,18 \text{ kg/m}$$

$$w_{db} = 4,5 \text{ kg/m}$$

$$w_{db} \cos 45^\circ = 3,18 \text{ kg/m}$$

$$w_{db} \sin 45^\circ = 3,18 \text{ kg/m}$$

$$w_{pa} = 10 \text{ kg/m}$$

$$w_{pa} \cos 45^\circ = 7,07 \text{ kg/m}$$

$$w_{pa} \sin 45^\circ = 7,07 \text{ kg/m}$$

WR

$$w_{pb} = 10 \text{ kg/m}$$

$$w_{pb} \cos 45^\circ = 7,07 \text{ kg/m}$$

$$w_{pb} \sin 45^\circ = 7,07 \text{ kg/m}$$

$$w_{dc} = 22,5 \text{ kg/m}$$

- Perhitungan Reaksi dititik K dan L

$$\sum m_k = 0$$

$$- R_{LV} \times 6 - w_{da} \cos 45^\circ \times 3 - w_{db} \cos 45^\circ \times 6 + w_{pa} \cos 45^\circ \times 3 + w_{pb} \times 0$$

$$R_{LV} = 8,30 \text{ kg}$$

$$\sum m_L = 0$$

$$- R_{UV} \times 6 - w_{da} \cos 45^\circ \times 3 - w_{db} \cos 45^\circ \times 6 + w_{pa} \cos 45^\circ \times 3 + w_{pb} \times 0$$

$$- R_{UV} \times 6 - 3,18 \times 3 - 3,18 \times 6 + 7,07 \times 3$$

$$R_{UV} = 8,30 \text{ kg}$$

Titik buhul k

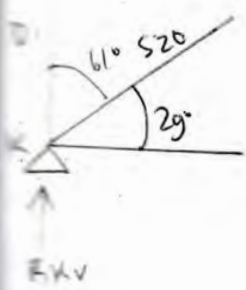

$$\sum H = 0$$

$$Wd_k + S_{20} \cos 29^\circ = 0$$

$$22,5 + 0,87 \times S_{20} = 0$$

$$S_{20} = -25,86 \text{ kg (Tekan)}$$

$$\sum V = 0$$

$$R_{UV} + D_1 + S_{20} \times \sin 29^\circ = 0$$

$$8,30 + D_1 + (-25,86) \times 0,48 = 0$$

$$D_1 = 4,1 \text{ kg (Tarik)}$$

Titik buhul H

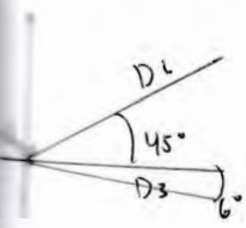

$$\sum V = 0$$

$$Wd_b \times \sin 45^\circ + D_1 + D_6 \times \sin 45^\circ + D_3 \times \sin 6^\circ = 0$$

$$4,5 \times 0,707 + 4,1 + D_6 \times \sin 45^\circ + D_3 \times \sin 6^\circ = 0$$

$$7,28 \times D_6 + 0,10 \times D_3 = 0 \dots (1)$$

$$\sum H = 0$$

$$D_6 \times \cos 45^\circ + D_3 \cos 6^\circ + Wd_b \times \cos 45^\circ = 0$$

$$0,707 \times D_6 + 0,99 \times D_3 + 4,5 \times 0,707 = 0$$

$$0,707 \times D_6 + 0,99 \times D_3 + 3,18 = 0 \dots (2)$$

dieliminasi ke pers 2

$$0,707 \times D_6 + 0,10 \times D_3 + 7,98 = 0$$

$$0,707 \times D_6 + 0,99 \times D_3 + 3,18 = 0$$

---

$$-0,89 \times D_3 + 4,8 = 0$$

$$D_3 = -5,39 \text{ kg (tekan)}$$

Substitusi diatas, maka diperoleh

$$7,98 + 0,707 \times D_6 + 0,10 \times D_3 = 0$$

$$7,98 + 0,707 \times D_6 + 0,10 \times (-5,39) = 0$$

$$D_6 = -9,22 \text{ kg (tekan)}$$

Titik buhul P

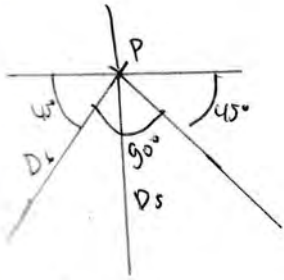

$$\sum H = 0$$

$$D_6 \times \cos 45^\circ + D_7 \times \cos 45^\circ + W_{da} \times \cos 45^\circ = 0$$

$$0,707 \times (-9,22) + 0,707 \times D_7 + 4,5 \times 0,707 = 0$$

$$D_7 = -4,71 \text{ (Tekan)}$$

$$\sum V = 0$$

$$D_6 \times \sin 45^\circ + W_{da} \times \cos 45^\circ + D_7 \times \sin 45^\circ + D_5 = 0$$

$$0,707 \times (-9,22) + 4,5 \times 0,707 + (-4,71) \times 0,707 + D_5 = 0$$

$$D_5 = 6,66 \text{ ug (Tarik)}$$

Titik buhul O

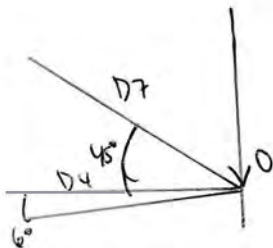

$$\sum H = 0$$

$$D_4 \times \cos 6^\circ + D_7 \times \cos 45^\circ = 0$$

$$0,99 \times D_4 + 0,707 \times (-4,71) = 0$$

$$D_4 = 3,36 \text{ ug (Tarik)}$$

$$\sum V = 0$$

$$D_7 \times \sin 45^\circ + D_4 \times \sin 6^\circ + D_2 = 0$$

$$(-4,71) \times 0,707 + 3,36 \times 0,10 + D_2 = 0$$

$$D_2 = 2,99 \text{ ug (Tarik)}$$

Titik buhul L

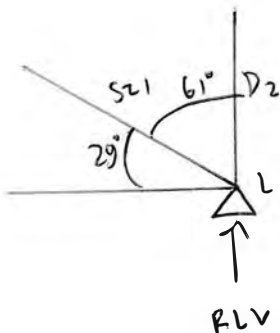

$$\sum V = 0$$

$$RLV = +D_2 + S_{21} \times \sin 38^\circ = 0$$

$$0,30 + 2,99 + 0,62 \times S_{21} = 0$$

$$S_{21} = -18,20 \text{ ug (Tekan)}$$

# TUGAS WAJIB STRUKTUR BAJA

---

## TABEL GAYA BATANG

PERHITUNGAN GAYA BATANG BEBAN ANGIN		
No Batang	Batang Tarik (+)	Batang Tekan (-)
D1	-	4.1
D2	-	2.99
D3	-	-5.39
D4	3.36	-
D5	6.66	-
D6	-	-9.22
D7	-	-4.71
S20	-	-25.86
S21	-	-18.20



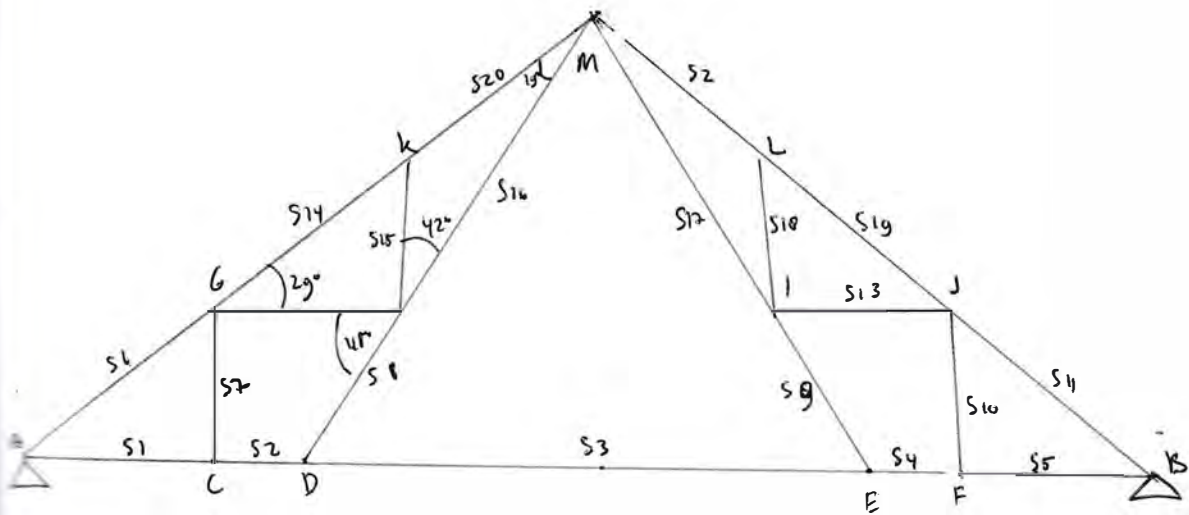

### Panjang rangka batang

- |                   |                   |
|-------------------|-------------------|
| $S_1 = 3, m$      | $S_{11} = 3,43 m$ |
| $S_2 = 1,5 m$     | $S_{12} = 3 m$    |
| $S_3 = 9 m$       | $S_{13} = 3 m$    |
| $S_4 = 1,5 m$     | $S_{14} = 3,43 m$ |
| $S_5 = 3, m$      | $S_{15} = 1,66 m$ |
| $S_6 = 3,43 m$    | $S_{16} = 4,48 m$ |
| $S_7 = 1,66 m$    | $S_{17} = 4,48 m$ |
| $S_8 = 2,24 m$    | $S_{18} = 2,33 m$ |
| $S_9 = 2,24 m$    | $S_{19} = 3,43 m$ |
| $S_{10} = 1,66 m$ | $S_{20} = 3,43 m$ |
|                   | $S_{21} = 3,43 m$ |

### - Beban mati

- Penutup atap =  $15,2 \times 5 \times 10 = 760 kg$   
 Pengikat atap =  $2 kg$   
 Gording =  $5 \times 4,76 \times 14 bh = 333,2 kg$   
 Pengikat gording =  $3 kg$   
 Rangka atap =  $75,56 \times 12,14 = 917,298 kg$

Total beban mati =  $2015,50 kg \approx 2016 kg$

Beban  $P_1 = 168 kg \times 2 titik = 336 kg$

$P_2 = 336 kg \times 5 titik = 1680 kg$

UNIVERSITAS MEDAN AREA

2016 kg

- Beban hidup

$$\begin{aligned} \text{Beban } P_1 &= 100 \text{ kg} \times 2 \text{ titik} = 200 \text{ kg} \\ \text{beban } P_2 &= 100 \text{ kg} \times 5 \text{ titik} = 500 \text{ kg} \\ &\hline &700 \text{ kg} \end{aligned}$$

- Beban angin

$$\text{Jarak gording (L)} = 1,27 \text{ m}$$

$$\text{Kemiringan } (\alpha) = 38^\circ$$

$$\text{Besarnya beban angin (w)} = 30, \text{ kg/m}^2$$

$$w_{da} = (C \times \alpha - 0,4) \times L \times w$$

$$w_{da} = (0,02 \times 38) - (0,40) \times 1,27 \times 30$$

$$w_{da} = 13,72 \text{ kg/m} = w_{db}$$

$$\alpha = 65^\circ - 90^\circ$$

$$w_{dc} = C \times L \times w$$

$$w_{dc} = 0,90 \times 1,27 \times 30$$

$$w_{dc} = 34,29$$

- Koef angin hisap (ch)

$$w_p = C \times L \times w$$

$$w_p = -0,40 \times 1,27 \times 30$$

$$w_p = -15,24 \text{ kg/m}$$

$$R_{LV} = 671,02 \text{ kg}$$

$$P_2 = 336 \text{ kg}$$

$$P_{2U} = 1007,02 \text{ kg}$$

$$R_{LV} = 671,02 \text{ kg}$$

$$P_1 = 168 \text{ kg}$$

$$P_{2L} = 1007,02 \text{ kg}$$

- Perhitungan reaksi titik A dan B

$$\sum M_B = 0$$

$$R_{AV} \times 18 - P_1 \times 0 - P_2 \times 3 - P_{2L} \times 6 - P_2 \times 9 - P_{2U} \times 12 - R_B \times 15 - P_1 \times 18 = 0$$

$$R_{AV} \times 18 - (168 \times 0) - (336 \times 3) - (1007,02 \times 6) - (336 \times 9) - (1007,02 \times 12) - (336 \times 15) - (168 \times 18) = 0$$

$$18 R_{AV} = 0 + 1008 + 6042,12 + 3024 + 12084 + 5040 + 3024$$

$$R_{AV} = 3022,36$$

UNIVERSITAS MEDAN AREA

$$R_{AV} = 1670,0 \text{ kg}$$

$\Sigma M = 0$

$$-RBV \times 18 + P_1 \times 0 + P_2 \times 3 + P_{2k} \times 6 + P_2 \times 9 + P_{2l} \times 12 - P_2 \times 15 - P_1 \times 18 = 0$$

$$-RBV \times 18 + (168 \times 0) + (336 \times 3) + (1007,02 \times 6) + (336 \times 9) + (1007,02 \times 12) + (336 \times 15) - (168 \times 18) = 0$$

$$18 RBV = 0 + 1008 + 6042,12 + 3024 + 12084 + 5040 - 3024$$

$$RBV = \frac{30222,36}{18}$$

$$RBV = 1679 \text{ kg}$$

Kontrol

$$\Sigma V = 0$$

$$RAV + RBV - P_1 - P_2 - P_{2k} - P_{2l} - P_2 - P_1 = 0$$

$$1679 + 1679 - 168 - 336 - 1007 - 336 - 1007 - 336 - 168 = 0$$

$$3358 - 3358 = 0 \text{ (Ok)}$$

- Perhitungan gaya batang

Titik buhul A

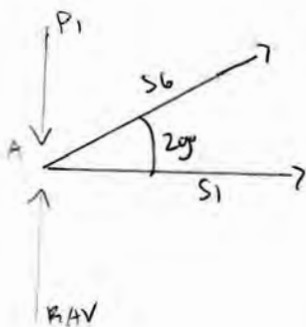

$$\Sigma V = 0$$

$$RAV + S_6 \sin 29 - P = 0$$

$$1679 + 0,48 S_6 - 168 = 0$$

$$- S_6 = \frac{1511}{0,48}$$

$$S_6 = -3147,9 \text{ kg (Tekan)}$$

$$\Sigma H = 0$$

$$S_6 \cos 29 + S_1 = 0$$

$$0,87 \times (-3147,9) + S_1 = 0$$

$$S_1 = 2738,67 \text{ kg (Tarik)}$$

Titik buhul C

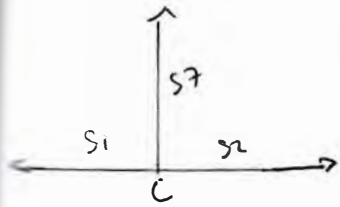

$$\sum V = 0$$

$$S7 = 0 \text{ kg}$$

$$\sum H = 0$$

$$S2 - S1 = 0$$

$$S2 - 2738,67 = 0$$

$$S2 = 2738,67 \text{ kg (tarik)}$$

Titik buhul G

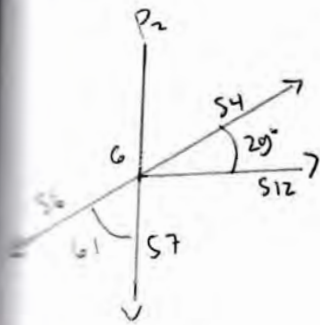

$$\sum V = 0$$

$$P2 + S7 + S6 \sin 29 + S14 \sin 29 = 0$$

$$336 + 0 + 0,48 \times -3147,9 + 0,48 \times S14 = 0$$

$$-S14 = \frac{1174,99}{0,48}$$

$$S14 = -2447,89 \text{ kg (tekan)}$$

$$\sum H = 0$$

$$S14 \cos 48 + S6 \cos 48 + S12 = 0$$

$$-2447,89 \times 0,66 + 2452,9 \times 0,66 + S12 = 0$$

$$S12 = 3234,54 \text{ kg (tarik)}$$

Titik buhul D

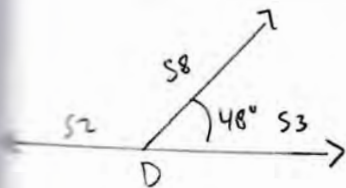

$$\sum V = 0$$

$$S8 \sin 48 = 0$$

$$S8 \times 0,74 = 0 \dots (1)$$

$$\sum H = 0$$

$$S8 \times \cos 48 + S2 + S3 = 0 \dots (2)$$

eliminasi per 1 dan 2

$$0,74 \times S8 = 0$$

$$0,66 \times S8 + 2738,67 + S3 = 0$$

$$\times 0,66$$

$$\times 0,74$$

$$0,48 \times S8 = 0$$

$$0,48 \times S8 + 2026,61 + S3 = 0$$



$$S_{20} = -2447.88 \text{ kg (Tumpu)}$$

$$\frac{t_{B'} \cdot a}{2129.66} = a_{25} -$$

$$a = 220 + t_{B'} \cdot a - 2447.88 - t_{B'} \cdot a$$

$$S_{14} \times \sin 61^\circ - S_{20} \sin 61^\circ = 0 = H_3$$

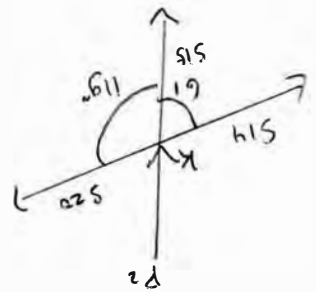

Titik buhul K

$$S_{15} = -4505.42 \text{ kg (tumpu)}$$

$$S_{15} = -2981.36 - 3707.06$$

$$a = t_{B'} \cdot a + t_{B'} \cdot a - (-5004.65) \times 0.74 = 0$$

$$S_{15} + 1028.8 + 0.74 \times S_{16} - S_{16} \times 0.74 = 0$$

Masukan nilai S16 ke Pers 1

$$S_{16} = -5009.65 \text{ (Tumpu)}$$

$$\frac{t_{B'} \cdot a}{2449.03} = a_{15} -$$

$$a = 2234.52 + 1028.8 + t_{B'} \cdot a + S_{16} \times 0.74 + S_{16} \times 0.66 = 0$$

$$a = 845.82 + 845.82 \times 0.74 + S_{16} \cos 48^\circ$$

$$0 = H_3$$

$$(1) \dots 0 = t_{B'} \cdot a + S_{16} \times 0.74 - t_{B'} \cdot a + 1028.8 + S_{16} \times 0.66 = 0$$

$$a = 845.82 + S_{16} \times \sin 48^\circ$$

$$0 = V_3$$

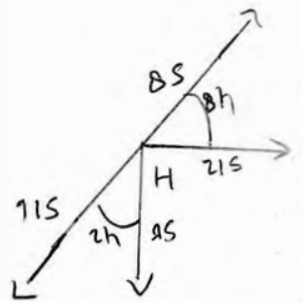

Titik buhul H

$$S_{20} = 1078.87 \text{ kg (tumpu)}$$

$$S_{20} = 2121.06$$

$$a = (1702.02 + t_{B'} \cdot a + 2338.67 + t_{B'} \cdot a) \times 0.66 + S_{20} \times 0.66 + 2338.67$$

$$0 = 2338.67 + S_{20} \times 0.66 + t_{B'} \cdot a + t_{B'} \cdot a$$

Masukan nilai S2 ke dalam Pers 2

## Perhitungan gaya batang akibat beban hidup

$$R_{KV} = 671,02 \text{ kg}$$

$$P_2 = 100 \text{ kg}$$

$$P_{2K} = 771,02 \text{ kg}$$

$$R_{LV} = 671,02 \text{ kg}$$

$$P_1 = 100 \text{ kg}$$

$$P_{2L} = 771,02 \text{ kg}$$

- Perhitungan reaksi titik A dan B

$$\sum M_B = 0$$

$$R_{AV} \times 18 - P \times 0 - P_2 \times 3 - P_2 \times 6 - P_2 \times 9 - P_{2K} \times 12 - P_2 \times 15 - P_1 \times 18 = 0$$

$$R_{AV} \times 18 - (100 \times 0) - (100 \times 3) - (771,02 \times 6) - (100 \times 9) - (771,02 \times 12) - (100 \times 15) -$$

$$R_{AV} = \frac{18378,36}{18}$$

$$18$$

$$R_{AV} = 1021 \text{ kg}$$

$$\sum M_A = -R_{BV} \times 18 + P_1 \times 0 + P_2 \times 3 + P_{2K} \times 6 + P_2 \times 9 + P_2 \times 12 + P_2 \times 15 + P_1 \times 18 = 0$$

$$-R_{BV} \times 18 + (100 \times 0) + (100 \times 3) + (771,02 \times 6) + (100 \times 9) + (771,02 \times 12) + (100 \times 15) + 100 \times 18 = 0$$

$$18 R_{BV} = 0 + 300 + 4626,12 + 900 + 9252,24 + 1500 + 1800$$

$$R_{BV} = \frac{18378,36}{18}$$

$$18$$

$$R_{BV} = 1021,02 \text{ kg}$$

Kontrol

$$\sum V = 0$$

$$R_{AV} + R_{BV} - P_1 - P_2 - P_{2K} - P_2 - P_{2L} - P_2 - P_1 = 0$$

$$1021,02 + 1021,02 - 100 - 100 - 771,02 - 100 - 771,02 - 100 - 100 = 0$$

$$2042,04 \text{ kg} - 2042,04 \text{ kg} = 0 \text{ (OK)}$$

# Perhitungan Gaya batang

Titik buhul A

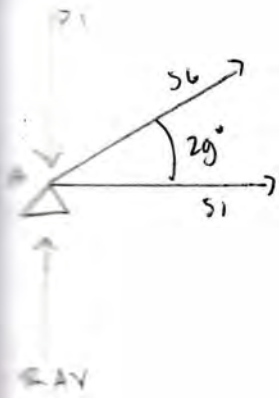

$$\sum V = 0$$

$$RAV + S_6 \sin 29 - P_1 = 0$$

$$1021 + 0,48 \times S_6 - 100 = 0$$

$$-S_6 = \frac{921}{0,48}$$

$$S_6 = -1918,75 \text{ kg (tekan)}$$

$$\sum H = 0$$

$$S_6 \cos 29 + S_1 = 0$$

$$0,87 \times (-1918,75) + S_1 = 0$$

$$S_1 = 1669,33 \text{ kg (tarik)}$$

Titik buhul C



$$\sum V = 0$$

$$S_7 = 0 \text{ kg}$$

$$\sum H = 0$$

$$S_2 - S_1 = 0$$

$$S_2 - 1669,33 = 0$$

$$S_2 = 1669,33 \text{ kg (Tarik)}$$

Titik buhul G



$$\sum V = 0$$

$$P_2 + S_7 + S_6 \sin 29 + S_{14} \sin 29 = 0$$

$$100 + 0 + 0,48 (-1918,75) + 0,4 \times S_{14} = 0$$

$$-S_{14} = \frac{821}{0,48}$$

$$S_{14} = -1710,41 \text{ kg (Tekan)}$$

$$\sum H = 0$$

$$S_{14} \cos 29 + S_6 \cos 29 + S_{12} = 0$$

Titik buhul D

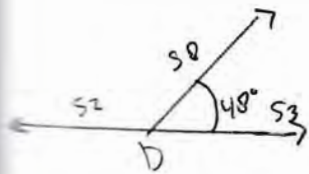

$$\sum V = 0$$

$$S8 \sin 48^\circ = 0$$

$$S8 \times 0,74 = 0 \dots (1)$$

$$\sum H = 0$$

$$S8 \cos 48 + S2 + S3 = 0$$

$$0,66 \times S8 + 1669,33 + S3 = 0 \dots (2)$$

Eliminasi Pers 1 dan 2

$$\begin{array}{r} 0,74 \times S8 \\ = 0 \end{array} \left| \begin{array}{l} \times 0,66 \\ \times 0,74 \end{array} \right.$$

$$0,66 \times S8 + 1669,33 + S3 = 0$$

$$0,456 \times S8 = 0$$

$$0,456 \times S8 + 1235,30 + S3 = 0$$

$$S3 = -1235,30 \text{ kg (tekan)}$$

Substitusikan nilai S3 ke Pers 2

$$0,66 \times S8 + 1669,33 + S3 = 0$$

$$0,66 \times S8 + 1669,33 + (-1235,30) = 0$$

$$S8 = \frac{434,03}{0,66}$$

$$S8 = 657,62 \text{ kg (Tarik)}$$

Titik buhul H

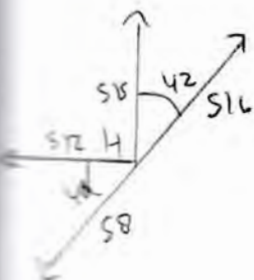

$$\sum V = 0$$

$$S15 + S8 \sin 48 + S16 \sin 48 = 0$$

$$S15 + 657,62 \times 0,74 - S16 \times 0,74 = 0 \dots (1)$$

$$\sum H = 0$$

$$S12 + S8 \cos 57 + S16 \cos 57 = 0$$

$$3157,36 + 657,62 \times 0,66 + S16 \times 0,66 = 0$$

$$\text{UNIVERSITAS MEDAN AREA} \quad S16 = \frac{749,38}{0,66}$$

titik buhu 1 k

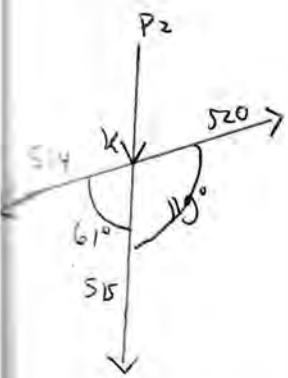

$$\sum H = 0$$

$$S_{14} \sin 48^\circ - S_{20} \sin 48^\circ = 0$$

$$0,87 \times -1710,41 - 0,87 \times S_{20} = 0$$

$$-S_{20} = \frac{1050,26}{0,788}$$

$$S_{20} = -1408,81 \text{ kg (Tekan)}$$

Besaran Gaya Sama Pada Batang-batang berikut ini

$$S_1 = S_5$$

$$S_2 = S_4$$

$$S_3 = S_3$$

$$S_6 = S_{11}$$

$$S_7 = S_{10}$$

$$S_8 = S_9$$

$$S_{12} = S_{13}$$

$$S_{14} = S_{19}$$

$$S_{15} = S_{18}$$

$$S_{16} = S_{17}$$

$$S_{20} = S_{21}$$

## TUGAS WAJIB STRUKTUR BAJA

### REKAPITULASI GAYA BATANG AKIBAT BEBAN TETAP

No. Batang	BEBAN MATI		BEBAN HIDUP		BEBAN TETAP	
	Batang Tarik (+)	Batang Tekan (-)	Batang Tarik (+)	Batang Tekan (-)	Batang Tarik (+)	Batang Tekan (-)
S 1	2738,67	-	1669.33	-	4408	-
S 2	2738,67	-	1669.33	-	4408	-
S 3	-	(2026.61)	-	(1235.30)	-	(3261.91)
S 4	2738,67	-	1669.33	-	4408	-
S 5	2738,67	-	1669.33	-	4408	-
S 6	-	(3147.9)	-	(1918.75)	-	(5066.65)
S 7	-	-	-	-	-	-
S 8	1078.87	-	657,62	-	1736,49	-
S 9	1078.87	-	657,62	-	1736,49	-
S 10	-	-	-	-	-	-
S 11	-	(3147.9)	-	(1918.75)	-	(5066.65)
S 12	3234.52	-	3157.36	-	6391.88	-
S 13	3234.52	-	3157.36	-	6391.88	-
S 14	-	(2447.89)	-	(1710.41)	-	(4158.3)
S 15	-	(4505,42)	-	(1326.85)	-	(5832,27)
S 16	-	(5009,65)	-	(1135.43)	-	(6145,08)
S 17	-	(5009,65)	-	(1135.43)	-	(6145,08)
S 18	-	(4505,42)	-	(1326.85)	-	(5832,27)
S 19	-	(2447.89)	-	(1710.41)	-	(4158.3)
S 20	-	(2447.88)	-	(1488.81)	-	(3936.69)
S 21	-	(2447.88)	-	(1488.81)	-	(3936.69)
D 1	-	(358.98)	-	(150.00)	-	(508,98)
D 2	-	(358.98)	-	(150.00)	-	(508,98)
D 3	982	-	280.9	-	1262.9	-
D 4	982	-	280.9	-	1262.9	-
D 5	-	(312.04)	-	100	-	(412.04)
D 6	-	(1374.8)	-	393.26	-	(1768,06)
D 7	-	(1374.8)	-	393.26	-	(1768,06)

# Perhitungan Gaya Batang Akibat beban angin datang

Perhitungan Reaksi dititik K dan L

$$\sum M_B = 0$$

$$R_{AV} \times 18 - W_{da} \sin 29^\circ \times 18 - W_{da} \sin 29^\circ \times 12 + W_{da} \sin 29^\circ \times 9 - 0 \times 6 - 0 \times 3 - 0 \times 0 = 0$$

$$R_{AV} \times 18 - 22,28 \times 18 - 22,28 \times 12 + 22,28 \times 9 - 0 \times 6 - 0 \times 3 - 0 \times 0 = 0$$

$$R_{AV} = 66,84$$

$$\sum M_A = 0$$

$$R_{BV} \times 18 - W_{da} \sin 29^\circ \times 0 - W_{da} \sin 29^\circ \times 3 - W_{da} \sin 29^\circ \times 6 + W_{da} \sin 29^\circ \times 9 - 0 \times 12$$

$$- 0 \times 15 - 0 \times 18 = 0$$

$$R_{BV} \times 18 - 22,28 \times 0 - 22,28 \times 3 - 22,28 \times 6 + 22,28 \times 9 - 0 \times 12 - 0 \times 15 - 0 \times 18 = 0$$

$$R_{BV} = 22,28 \text{ kg}$$

$$\sum M_L = 0 \rightarrow R_{AV} + R_{BV} - (4 \times W_{da} \sin 29^\circ)$$

$$= 89,11 \text{ kg} - 89,11 \text{ kg} = 0 \rightarrow \text{OK}$$

Perhitungan gaya batang

Titik buhul A

$$\sum V = 0$$

$$R_{AV} + S_6 \sin 29^\circ - W_{da} \sin 29^\circ = 0$$

$$66,84 + 0,48 \times S_6 - 22,28 = 0$$

$$- S_6 = \frac{44,56}{0,48}$$

$$S_6 = -92,83 \text{ kg (Tekan)}$$

$$\sum H = 0$$

$$S_6 \cos 29^\circ + S_1 + W_{da} \cos 29^\circ = 0$$

$$UNIVERSITAS MEDANA \text{ (A)} \quad (-92,83) + S_1 + 17,41 = 0$$

$$S_1 = 63,35 \text{ kg (Tarik)}$$

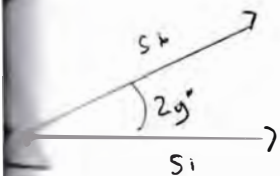

Titik Buhul A

$$\sum V = 0$$

$$R_{AV} + S_6 \sin 29^\circ - W_{da} \sin 29^\circ = 0$$

$$66,84 + 0,48 \times S_6 - 22,28 = 0$$

$$-S_6 = \frac{44,56}{0,48}$$

$$S_6 = -92,83 \text{ kg (Tekan)}$$

$$\sum H = 0$$

$$S_6 \cos 29^\circ + S_1 + W_{da} \cos 29^\circ = 0$$

$$0,87 \times (-92,83) + S_1 + 17,41 = 0$$

$$S_1 = 63,35 \text{ kg (Tarik)}$$

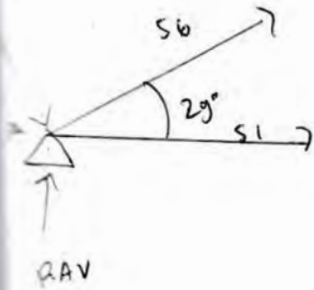

Titik buhul C

$$\sum V = 0$$

$$S_7 = 0 \text{ kg}$$

$$\sum H = 0$$

$$S_2 - S_1 = 0$$

$$S_2 - 63,35 = 0$$

$$S_2 = 63,35 \text{ kg (Tarik)}$$

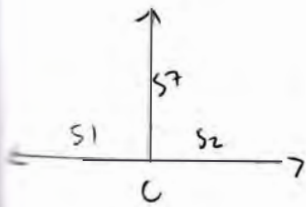

Titik buhul G

$$\sum V = 0$$

$$W_{da} \sin 29^\circ + S_7 + S_6 \sin 29^\circ + S_{14} \sin 29^\circ = 0$$

$$22,28 + 0 + 0,48 \times (-92,83) + 0,48 \times S_{14} = 0$$

$$-S_{14} = \frac{22,27}{0,48}$$

$$S_{14} = -46,39 \text{ kg (Tekan)}$$

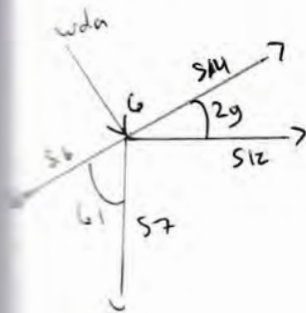

UNIVERSITAS MEDAN AREA  $\sum H = 0$

$$S_{14} \cos 29^\circ + S_6 \times \cos 29^\circ + S_{12} = 0$$



Titik Buhul D

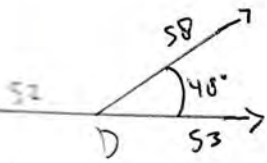

$$\sum V = 0$$

$$S8 \sin 48^\circ = 0$$

$$S8 \times 0,74 = 0 \dots (1)$$

$$\sum H = 0$$

$$S8 \cos 48 + S2 + S3 = 0$$

$$0,66 \times S8 + 63,35 + S3 = 0 \dots (2)$$

Pers 1 dan 2 di eliminasi

$$0,74 \times S8 = 0 \quad \left| \begin{array}{l} \times 0,66 \\ \times 0,74 \end{array} \right.$$

$$0,66 \times S8 + 63,35 + S3 = 0$$

---

$$0,48 \times S8 = 0$$

$$0,48 \times S8 + 46,87 + S3 = 0$$

---

$$S3 = -46,87 \text{ kg (tekan)}$$

Masukkan nilai S3 ke Pers 2

$$0,66 \times S8 + 63,35 + S3 = 0$$

$$0,66 \times S8 + 63,35 - 46,87 = 0$$

$$S8 = \frac{16,48}{0,66}$$

$$0,66$$

$$S8 = 24,96 \text{ kg (Tarik)}$$

Titik Buhul H

$$\sum V = 0$$

$$S15 + S8 \sin 48 + S16 \sin 48 = 0$$

$$S15 + 24,96 \times 0,74 - S16 \times 0,74 = 0 \dots (1)$$

$$\sum H = 0$$

$$S12 + S8 \cos 48 + S16 \cos 48 = 0$$

$$121,12 + 24,96 \times 0,66 + S16 \times 0,66 = 0$$

$$-S16 = 137,59$$

Memasukkan nilai  $S_{16}$  ke pers 1

$$S_{15} + 24,96 \times 0,74 - S_{16} \times 0,74 = 0$$

$$S_{15} + 24,96 \times 0,74 + 208,47 \times 0,74 = 0$$

$$S_{15} = -172,73 \text{ kg (tekan)}$$

Titik buhul K

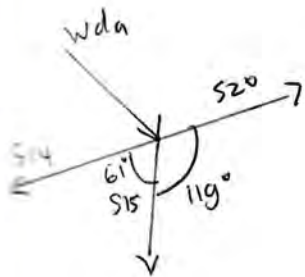

$$\sum H = 0$$

$$S_{14} \sin 61^\circ - S_{20} \sin 61^\circ = 0$$

$$0,87 \times -46,39 - 0,87 \times S_{20} = 0$$

$$-S_{20} = \frac{40,35}{0,87}$$

$$S_{20} = -46,37 \text{ kg (tekan)}$$

Titik buhul B

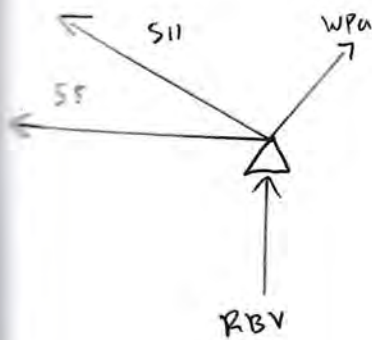

$$\sum V = 0$$

$$RBV + S_{11} \times \sin 29^\circ = 0$$

$$22,28 + 0,48 \times S_{11} = 0$$

$$-S_{11} = \frac{22,28}{0,48}$$

$$S_{11} = -46,41 \text{ kg (tekan)}$$

$$\sum H = 0$$

$$S_{11} \times \cos 29^\circ + S_5 = 0$$

$$0,87 \times (-46,41) + S_5 = 0$$

$$S_5 = 40,37 \text{ kg (Tarik)}$$

Titik buhul F

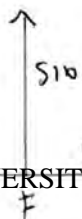

$$\sum V = 0$$

$$S_{10} = 0 \text{ kg}$$

$$\sum H = 0$$

$$S_4 - S_5 = 0$$

$$S_4 = 40,37$$

Titik buhul J

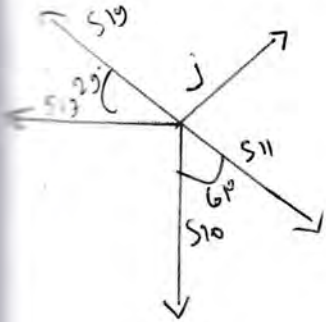

$$\sum V = 0$$

$$S_{10} + S_{11} \sin 2\theta + S_{12} \sin 2\theta = 0$$

$$0 + 0,48x - 46,41 + 0,48x S_{12} = 0$$

$$-S_{12} = \frac{22,27}{0,48}$$

$$S_{12} = -46,39 \text{ kg (Tekan)}$$

$$\sum H = 0$$

$$S_{12} \cos 2\theta + S_{11} \cos 2\theta + S_{13} = 0$$

$$46,41 \times 0,87 + -46,41 \times 0,87 + S_{13} = 0$$

$$S_{13} = 80,75 \text{ kg (Tarik)}$$

Titik buhul E

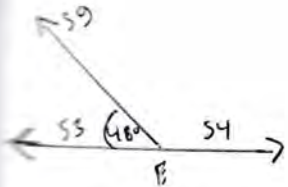

$$\sum V = 0$$

$$S_9 \sin 48 = 0$$

$$S_9 \times 0,74 = 0 \dots (1)$$

$$\sum H = 0$$

$$S_9 \cos 48 + S_4 + S_3 = 0$$

$$0,66 \times S_9 + 40,37 + S_3 = 0 \dots (2)$$

Eliminasi Pers 1 dan 2

$$\begin{array}{r} 0,74 \times S_9 = 0 \quad \times 0,66 \\ 0,66 \times S_9 + 40,37 + S_3 = 0 \quad \times 0,74 \end{array}$$

$$0,456 \times S_9 = 0$$

$$0,456 \times S_9 + 29,87 + S_3 = 0$$

$$S_3 = -29,87 \text{ kg (tekan)}$$

Masukkan nilai S3 ke pers 2

$$0,66 \times S_9 + 40,37 + (-29,87) = 0$$

$$0,66 \times S_9 + 40,37 + (-29,87) = 0$$

Titik buhul I

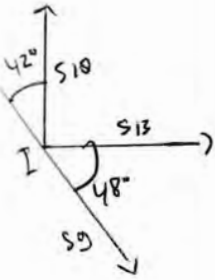

$$\sum V = 0$$

$$S_{18} + S_9 \sin 42^\circ + S_{17} \sin 48^\circ = 0$$

$$S_{18} + 15,9 \times 0,74 - S_{17} \times 0,74 = 0 \dots (1)$$

$$\sum H = 0$$

$$S_{13} + S_9 \cos 42^\circ + S_{17} \cos 48^\circ = 0$$

$$80,73 + 15,9 \times 0,66 + S_{17} \times 0,66 = 0$$

$$-S_{17} = \frac{91,24}{0,66}$$

$$S_{17} = -138,24 \text{ kg (Tekan)}$$

Memasukkan nilai  $S_{17}$  ke pers 1

$$S_{18} + 15,9 \times 0,74 - S_{17} \times 0,74 = 0$$

$$S_{18} + 15,9 \times 0,74 - (-138,24) \times 0,74 = 0$$

$$S_{18} = -114,06 \text{ kg (Tekan)}$$

Titik Buhul L

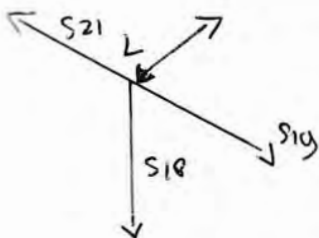

$$\sum H = 0$$

$$S_{19} \sin 52^\circ - S_{21} \sin 52^\circ = 0$$

$$0,87 \times -46,39 - 0,87 \times S_{21} = 0$$

$$-S_{21} = \frac{40,35}{0,87}$$

$$S_{21} = -57,64 \text{ kg (Tekan)}$$

## TUGAS WAJIB STRUKTUR BAJA

### REKAPITULASI GAYA BATANG AKIBAT BEBAN TETAP

No. Batang	BEBAN TETAP		BEBAN ANGIN		BEBAN DIPAKAI	
	Batang Tarik (+)	Batang Tekan (-)	Batang Tarik (+)	Batang Tekan (-)	Batang Tarik (+)	Batang Tekan (-)
S 1	4408	-	63.35	-	4408	-
S 2	4408	-	63.35	-	4408	-
S 3	-	(3261.91))	-	(46.87)	-	(3261.91)
S 4	4408	-	40.37	-	4408	-
S 5	4408	-	40.37	-	4408	-
S 6	-	(5066.65)	-	(92.83)	-	(5066.65)
S 7	-	-	-	-	-	-
S 8	1736,49	-	24.96	-	1736,49	-
S 9	1736,49	-	24.96	-	1736,49	-
S 10	-	-	-	-	-	-
S 11	-	(5066.65)	-	(36.19)	-	(5066.65)
S 12	6391.88	-	121.12	-	6391.88	-
S 13	6391.88	-	80.75	-	6391.88	-
S 14	-	(4158.3))	-	(46.39)	-	(4158.3)
S 15	-	(5832,27)	-	(172.73)	-	(5832,27)
S 16	-	(6145,08)	-	(208,47)	-	(6145,08)
S 17	-	(6145,08)	-	(138.24)	-	(6145,08)
S 18	-	(5832,27)	-	(114.06)	-	(5832,27)
S 19	-	(4158.3))	-	(46.39)	-	(4158.3)
S 20	-	(3936.69)	-	(46.37)	-	(3936.69)
S 21	-	(3936.69)	-	(57.64)	-	(3936.69)
D 1	-	(508,98)	-	(4.1)	-	(508,98)
D 2	-	(508,98)	-	(2.99)	-	(508,98)
D 3	1262.9	-	-	(5.39)	1262.9	-
D 4	1262.9	-	3.36	-	1262.9	-
D 5	-	(412.04)	6.66	-	-	(412.04)
D 6	-	(1768,06)	-	(9.22)	-	(1768,06)
D 7	-	(1768,06)	-	(4.71)	-	(1768,06)

# TUGAS WAJIB KONSTRUKSI BAJA

Apabila jarak gording > 1,60 meter,  
harus ditambah gording, dapat diletakkan ditengah.

Seng gelombang panjang 1,80 meter

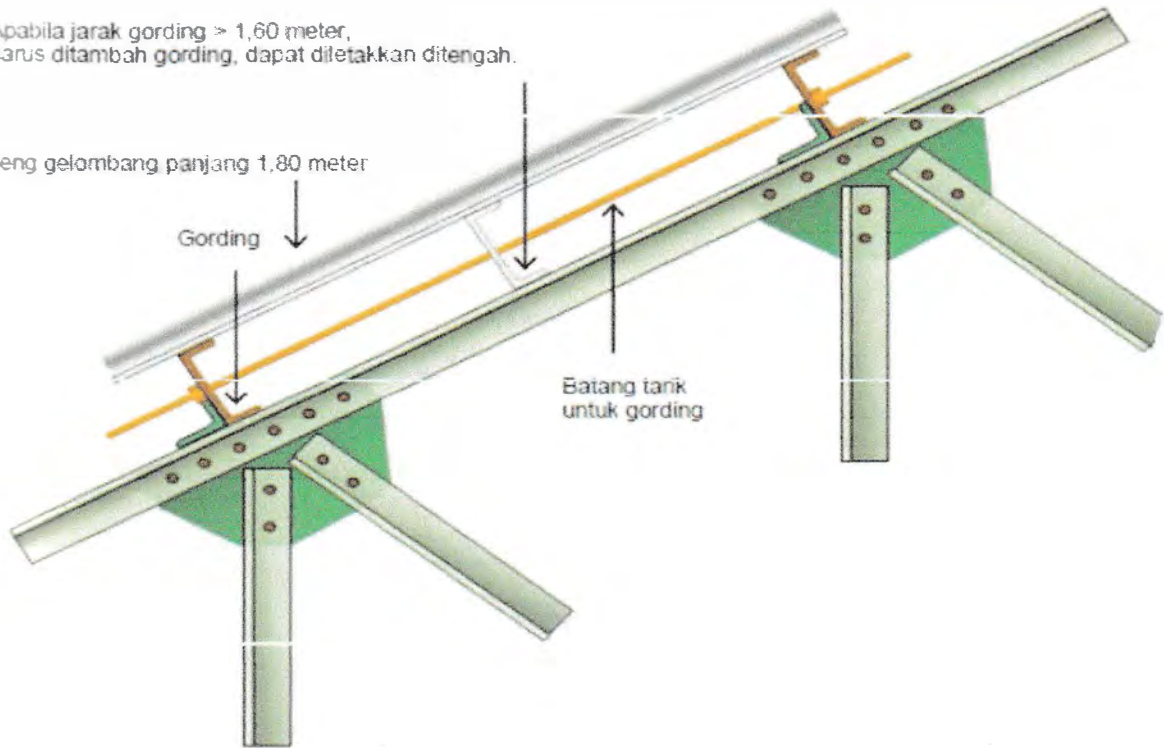

## 1. DIMENSI GORDING DALAM 3 (TIGA) VARIASI

Jarak Gording Dalam Perencanaan Ini Harus Disesuaikan Dengan Ukuran Penutup Atap, Dalam Perencanaan ini penutup atap yang digunakan :

**SENG BJLS, DENGAN PANJANG,  $L = 1.80 \text{ M}$**

Dengan Demikian, Dengan Jarak Overlap BJLS =  $0.20 \text{ m} \times 2$  (Atas Dan Bawah), Sehingga Panjang Efektif Seng BJLS =  $1.40 \text{ M}$

**JARAK GORDING  $\leq 1.40 \text{ M}$**

Perencanaan Gording Ini Dicoba Dengan 3 (Tiga) Variasi Yaitu :

**1. VARIASI-A TANPA BATANG TARIK**

**2. VARIASI-B DENGAN SATU BATANG TARIK (TUNGGAL)**

**3. VARIASI-C DENGAN DUA BATANG TARIK (GANDA)**

# TUGAS WAJIB KONSTRUKSI BAJA

## VARIASI-A TANPA BATANG TARIK

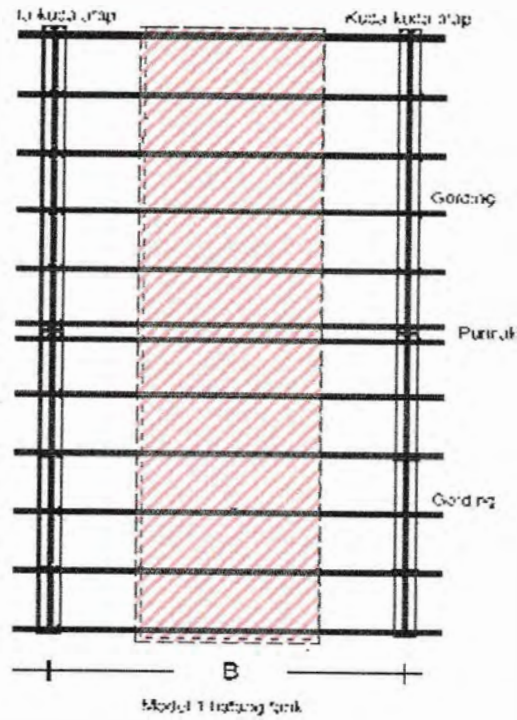

D

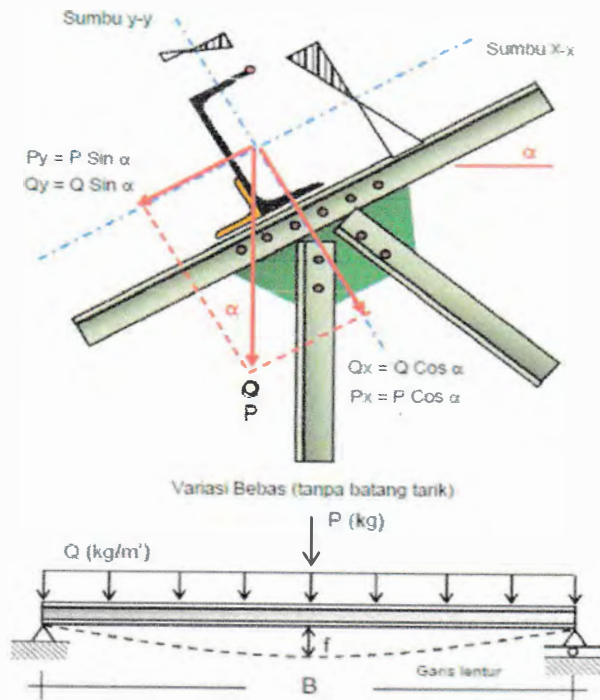

## Variasi - A Tanpa batang tarik

### a. Perhitungan beban

#### a. Beban mati

- penutup atap seng bergelombang
- Asumsi Berat Gording

$$= 1,27 \times 10 = 12,70 \text{ kg/m}$$

$$= 23,80 \text{ kg/m}$$

$$\text{Jumlah QDL} = 36,50 \text{ kg/m}$$

#### b. Beban hidup

- Beban terpusat ditengah batang

$$= 100 \text{ kg}$$

$$\text{Jlh PLL} = 100 \text{ kg}$$

#### c. Beban Angin

- pada bidang angin  $\alpha = 65^\circ - 90^\circ \rightarrow c = 0,90$ ,  $\alpha \leq 65^\circ \rightarrow c = 0,02 \times \alpha - 0,40$   
(Angin datang)
- pada bidang tidak ada angin  $\rightarrow c = -0,40$   
(Angin Pergi)
- Beban angin yg diambil  $= 0,90 \times 1,27 \times 25 = 28,58 \text{ kg/m}$

### B. Tegangan Izin

- mutu baja = St. 37
- Pembebanan tetap  $= 1600 \text{ kg/cm}^2 (\sigma_t)$
- Pembebanan Sementara = ~~2080~~  $1,3 \times 1600 = 2080 \text{ kg/cm}^2 (\sigma_s)$

### C. Lendutan max yg diizinkan

- Batas lendutan max arah vertikal untuk DL dan LL

$$f = \frac{1}{250} \times B = \frac{1}{250} \times 5 = 0,02 \text{ m} = 2,00 \text{ cm}$$

### D. Perhitungan momen untuk masing-masing Beban

#### a. Beban mati (QDL)

$$M_{yG} = \frac{1}{8} \times Q_{DL} \times \cos 2\theta \times B^2 = \frac{1}{8} \times 36,50 \times 0,970 \times 25 = 99,23 \text{ kg.m}$$

$$M_{xG} = \frac{1}{8} \times Q_{DL} \times \sin 2\theta \times B^2 = \frac{1}{8} \times 36,50 \times 0,480 \times 25 = 54,75 \text{ kg.m}$$

#### b. Beban hidup (PLL)

$$M_{yP} = \frac{1}{4} \times P_{LL} \times \cos 2\theta \times B = \frac{1}{4} \times 100 \times 0,970 \times 5 = 108,75 \text{ kg.m}$$

$$M_{xP} = \frac{1}{4} \times P_{LL} \times \sin 2\theta \times B = \frac{1}{4} \times 100 \times 0,480 \times 5 = 60,00 \text{ kg.m}$$



### C. Beban Angin (W<sub>L</sub>)

$$M_{yW} = 0 \text{ kg}\cdot\text{m}$$

$$M_{xW} = \frac{1}{8} \times W D L \times B^2 = \frac{1}{8} \times 28,58 \times 25 = 89,30 \text{ kg}\cdot\text{m}$$

### E. Perhitungan momen maksimum dengan kombinasi beban

#### a. Pembebanan tetap ( $\sigma_t = 1600 \text{ kg/cm}^2$ )

$$M_{y\text{max}} = M_{yQ} + M_{yP} = 99,23 + 108,75 \text{ kg}\cdot\text{m} = 207,98 \text{ kg}\cdot\text{m}$$

$$M_{x\text{max}} = M_{xQ} + M_{xP} = 54,75 + 60 = 114,75 \text{ kg}\cdot\text{m}$$

#### b. Pembebanan Sementara ( $\sigma_s = 2080 \text{ kg/cm}^2$ )

$$M_{y\text{max}} = M_{yQ} + M_{yP} + M_{yW} = 99,23 + 108,75 + 0 = 207,98 \text{ kg}\cdot\text{m}$$

$$M_{x\text{max}} = M_{xQ} + M_{xP} + M_{xW} = 54,75 + 60,00 + 89,30 = 204,05 \text{ kg}\cdot\text{m}$$

#### c. Momen max yg digunakan utk Perhitungan

$$M_{x\text{max}} = 204,05 \text{ kgm} = 20.405 \text{ kg cm}$$

### F. Perhitungan Tahanan momen untuk memperoleh dimensi Profil

$$\sigma_s = \frac{M_{x\text{max}}}{W}$$

$$2080 = \frac{20.405}{W}$$

$$W = \frac{20.405}{2080}$$

$$W = 9,81 \text{ cm}^3$$

# TUGAS WAJIB KONSTRUKSI BAJA

## 2. VARIASI-B DENGAN SATU BATANG TARIK (TUNGGAL)

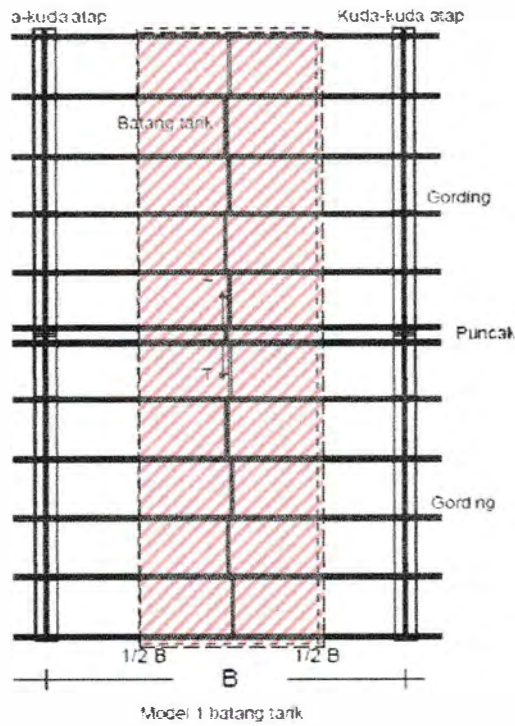

D

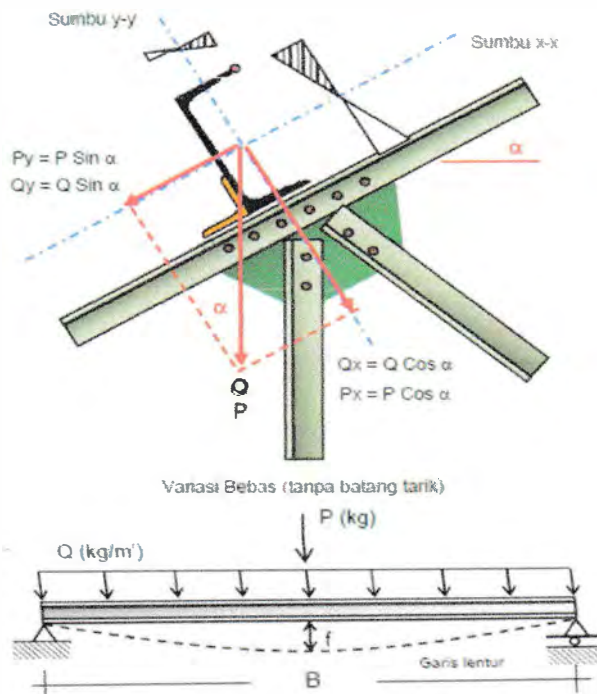

2 Variasi - B dengan satu batang tarik (tunggal)

- Rekap Perhitungan Item A S C Item D Variasi A

$$QDL = 36,50 \text{ kg.m}$$

$$PLL = 100 \text{ kg}$$

$$WU = 28,58 \text{ kg}$$

$$\sigma_t = 1600 \text{ kg.m}$$

$$\sigma_s = 2080 \text{ kg.m}$$

$$f = 2 \text{ cm}$$

$$YB = 2,5 \text{ m}$$

- Perhitungan momen max dengan kombinasi beban

a. beban mati (QDL)

$$M_{yQ} = \frac{1}{8} \times 36,50 \times 0,870 \times 6,25 = 24,80 \text{ kg.m}$$

$$M_{xQ} = \frac{1}{8} \times 36,50 \times 0,480 \times 6,25 = 13,68 \text{ kg.m}$$

b. beban hidup (PLL)

$$M_{yP} = \frac{1}{4} \times 100 \times 0,870 \times 2,5 = 54,37 \text{ kg.m}$$

$$M_{xP} = \frac{1}{4} \times 100 \times 0,480 \times 2,5 = 30 \text{ kg.m}$$

c. beban angin (WU)

$$M_{yW} = 0 \text{ kg.m}$$

$$M_{xW} = \frac{1}{8} \times 28,58 \times 2,5 = 8,93 \text{ kg.m}$$

- Perhitungan momen max dengan kombinasi beban

$$M_{x\max} = M_{xQ} + M_{xP} + M_{xW} = 13,68 + 30 + 8,93 = 52,61 \text{ kg.m} \approx 53 \text{ kg.m}$$

- Perhitungan tahanan momen untuk memperoleh dimensi profil

$$\sigma_s = \frac{M_{x\max}}{W}$$

$$2080 = \frac{53}{W}$$

$$W = \frac{53}{2080}$$

# TUGAS WAJIB KONSTRUKSI BAJA

## 3. VARIASI-C DENGAN DUA BATANG TARIK (GANDA)

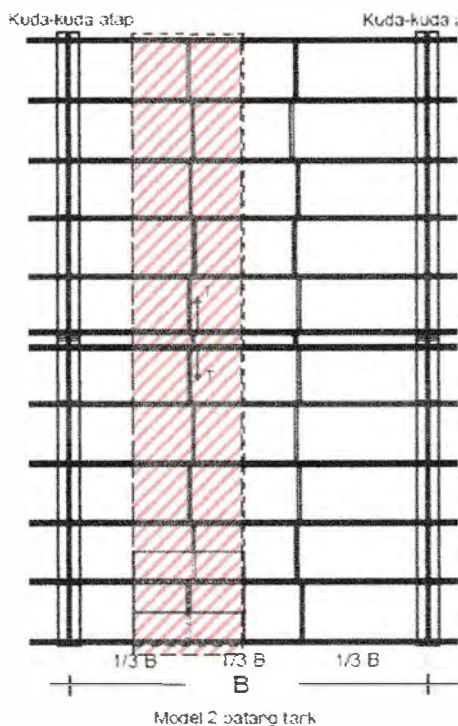

D

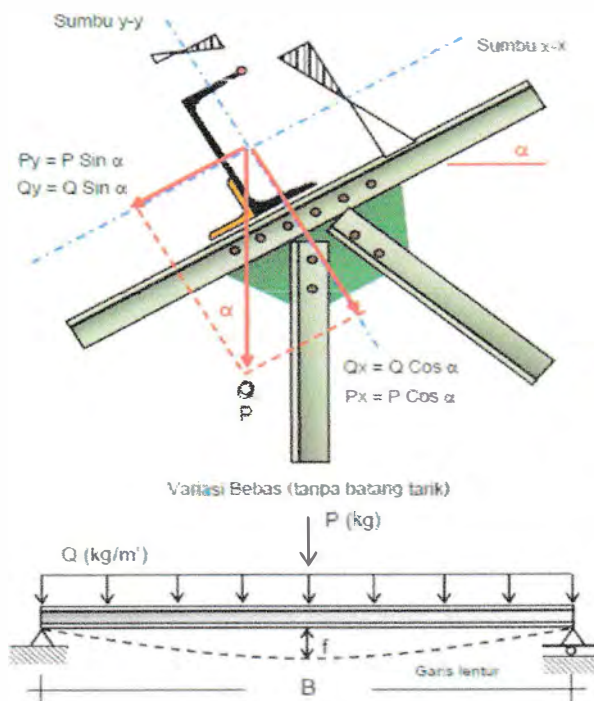

≡ Variasi C dengan 2 batang tarik (Ganda)

- Rekat Perhitungan Item A & Item B Variasi A

$$QDL = 36,50 \text{ kg.m}$$

$$PLL = 100 \text{ kg}$$

$$WLL = 28,50 \text{ kg.m}$$

$$\sigma_s = 1600 \text{ kg.m}$$

$$\sigma_s = 2080 \text{ kg.m}$$

$$F = 2 \text{ cm}$$

$$\frac{1}{3} B = 1,67 \text{ m}$$

- Perhitungan momen max dengan kombinasi beban

a. beban mati (QDL)

$$M_{yQ} = \frac{1}{8} \times 36,50 \times 0,870 \times 2,8 = 11,03 \text{ kg.m}$$

$$M_{xQ} = \frac{1}{8} \times 36,50 \times 0,480 \times 2,8 = 6,08 \text{ kg.m}$$

b. beban hidup (PLL)

$$M_{yP} = \frac{1}{4} \times 100 \times 0,870 \times 1,7 = 36,25 \text{ kg.m}$$

$$M_{xP} = \frac{1}{4} \times 100 \times 0,480 \times 1,7 = 20 \text{ kg.m}$$

c. Beban angin (WLL)

$$M_{yW} = 0 \text{ kg.m}$$

$$M_{xW} = \frac{1}{8} \times 28,50 \times 2,8 = 9,92 \text{ kg.m}$$

- Perhitungan momen max dengan kombinasi beban

$$M_{x \max} = 36,01 \text{ kg.m} = 36 \text{ kg.cm}$$

- Perhitungan tahanan momen untuk memperoleh dimensi profil

$$\sigma_s = \frac{M_{x \max}}{W}$$

$$2080 = \frac{36}{W}$$

$$W = \frac{36}{2080}$$

## Pemilihan Profil Gording

A. Dari hasil Perhitungan

1. Variasi A Tanpa batang tarik

$$\text{Tahanan momen} = 9,81 \text{ cm}^3$$

2. Variasi B Dengan 1 batang tarik (tunggal)

$$\text{Tahanan momen} = 0,02 \text{ cm}^3$$

3 Variasi C Dengan dua batang tarik (Ganda)

$$\text{Tahanan momen} = 0,02 \text{ cm}^3$$

W yang diambil harus  $\geq 0,02 \text{ cm}^3$  dan  $\leq 9,81 \text{ cm}^3$

Data yang mendekati adalah

$$C75 \times 45 \times 15 \times 1,6 \text{ W} = 7,24 \text{ cm}^3$$

$$W_x = 7,24 \text{ cm}^3$$

$$W_y = 3,13 \text{ cm}^3$$

$$I_x = 271 \text{ cm}^3$$

$$I_y = 8,71 \text{ cm}^3$$

## 5. Kontrol Tegangan

1. Variasi A tanpa Batang tarik

$$\sigma_s = \frac{M_{max}}{W_x} + \frac{M_{y_{max}}}{W_y}$$

$$2080 \geq \frac{204,05}{7,24} + \frac{207,98}{3,13}$$

$$2080 \geq 28,18 + 66,44$$

$$2080 \geq 94,62 \text{ (OK)}$$

2. Variasi B dengan 1 batang tarik (tunggal)

$$2080 \geq \frac{53}{7,24} + \frac{79}{3,13}$$

$$2080 \geq 7,32 + 25,23$$

$$2080 \geq 32,55 \text{ (OK)}$$

3. Variasi C dengan dua batang tarik (Ganda)

$$2080 \geq \frac{3601}{7,24} + \frac{47,20}{3,13}$$

$$2080 \geq 4,97 + 15,10$$

$$2080 \geq 20,07 \text{ (OK)}$$

## 6. Kontrol lendutan

Variasi A Tanpa batang tarik

Data

$$QDL = 36,50 \text{ kg}\cdot\text{m}$$

$$PU = 100 \text{ kg}$$

$$WU = 28,58 \text{ kg}$$

$$EI = 2,10 \times 10^6 \text{ (} 2,1 \times 10^6 \text{)}$$

$$I_x = 27,1 \text{ cm}^4$$

$$I_y = 8,71 \text{ cm}^4$$

$$\sin 29^\circ = 0,480$$

$$\cos 29^\circ = 0,870$$

$$B = 5 \text{ m}$$

a. beban mati (QDL)

$$F_x = \frac{4}{384} \times \frac{QDL \times \sin 29^\circ \times B^4}{EI \times L^3} \rightarrow \times 10^6$$

$$= 0,01 \times \frac{110,950 \times 1,1 \times 10^{10}}{5,69 \times 10^7}$$

$$= 2 \text{ cm}$$

$$F_y = \frac{4}{384} \times \frac{QDL \times \cos 29^\circ \times B^4}{EI \times L^3}$$

$$= \frac{4}{384} \times \frac{1,98 \times 10^{10}}{1,83 \times 10^7}$$

$$= 11,30 \text{ cm} > 2,00 \text{ cm} \quad \text{lendutan Ok}$$



## 2 Variasi B dengan 1 batang Tank (tunggal)

Data

$$QDL = 36,50 \text{ kg.m} \quad \sin 29^\circ = 0,480$$

$$PLL = 100 \text{ kg} \quad \cos 29^\circ = 0,876$$

$$WLL = 28,58 \text{ kg.m} \quad 1/2 B = 20 \text{ m}$$

$$EI = 2,1 \times 10^6$$

$$Ix = 2,71 \text{ cm}^4$$

$$Iy = 8,71 \text{ cm}^4$$

a. beban mati (QDL)

$$F_x = \frac{4}{384} \times \frac{2,8 \times 10^8}{5,69 \times 10^7}$$

$$= 0,05 \text{ cm}$$

$$F_y = \frac{4}{384} \times \frac{5,08 \times 10^8}{1,83 \times 10^7}$$

$$= 0,29 \text{ cm}$$

b. beban mati (PLL)

$$F_x = \frac{1}{48} \times \frac{PLL \times \sin 29^\circ \times 1/2 B^4}{EI \times I_x}$$

$$= \frac{1}{48} \times \frac{7,68 \times 10^8}{5,69 \times 10^7}$$

$$= 0,28 \text{ cm}$$

$$F_y = \frac{1}{48} \times \frac{PLL \times \cos 29^\circ \times 1/2 B^4}{EI \times I_y}$$

$$= \frac{1}{48} \times \frac{1,39 \times 10^9}{1,83 \times 10^7}$$

$$= 1,59 \text{ cm}$$

c. beban angin (WLL)

$$F_x = \frac{4}{384} \times \frac{WLL \times \sin 29^\circ \times 1/2 B^4}{EI \times I_x}$$

$$= \frac{4}{384} \times \frac{2,10 \times 10^8}{5,69 \times 10^7}$$

$$= 0,04 \text{ cm}$$

d. kombinasi lendutan

$$F_x = 0,05 + 0,28 = 0,33 \text{ cm}$$

$$F_y = 0,29 + 1,59 = 1,87 \text{ cm}$$

Mana lendutan max

$$f_{max} = \sqrt{f_x^2 + f_y^2}$$

$$= \sqrt{0,11 + 3,51}$$

$$= 1,90 \text{ cm} \leq 2 \text{ cm} \text{ Lendutan (OK)}$$

≡ Variasi C Dengan dua batang terna (Ganda)

Data

$$1/3 B = 1,67$$

a. Beban Mati (DL)

$$f_x = \frac{4}{384} \times \frac{1,36 \times 10^8}{5,69 \times 10^7}$$

$$= 0,02 \text{ cm}$$

$$f_y = \frac{3}{384} \times \frac{2,47 \times 10^8}{1,83 \times 10^7}$$

$$= 0,14 \text{ cm}$$

b. Beban hidup (PL)

$$f_x = \frac{1}{48} \times \frac{3,73 \times 10^8}{5,69 \times 10^7}$$

$$= 0,14$$

$$f_y = \frac{1}{48} \times \frac{6,77 \times 10^8}{1,83 \times 10^7}$$

$$= 0,77 \text{ cm}$$

c. Beban angin

$$f_x = \frac{4}{384} \times \frac{1,07 \times 10^8}{5,69 \times 10^7}$$

$$= 0,02$$

d. Kombinasi lendutan

$$f_x = 0,02 + 0,14 = 0,16 \text{ cm}$$

$$f_y = 0,14 + 0,77 = 0,91 \text{ cm}$$

Mana lendutan max

$$f_{max} = \sqrt{f_x^2 + f_y^2}$$

$$= \sqrt{0,03 + 0,83}$$

$$= 0,93 \text{ cm} \leq 2 \text{ cm} \text{ lendutan (OK)}$$

## 7. Dimensi dan Variasi Gording

Profil baja yang digunakan

C 75 x 45 x 15 x 1,6 mm

$$\begin{array}{ll} A = 75 \text{ mm} & I_x = 27,1 \text{ cm}^4 \\ B = 45 \text{ mm} & I_y = 8,71 \text{ cm}^4 \\ C = 15 \text{ mm} & W_x = 7,24 \text{ cm}^3 \\ t = 1,6 \text{ mm} & W_y = 3,13 \text{ cm}^3 \\ q = 2,32 \text{ mm} & F = 2,952 \text{ cm}^3 \end{array}$$

## 8. Dimensi Batang Tarik

A. Beban yang bekerja

$$\begin{array}{ll} - \text{Penutup Atap Seng bergelombang} & = 1,27 \times 1,67 \times 10 \times 0,480 = 10,18 \text{ kg} \\ - \text{Gording} & = 1,67 \times \frac{2,32}{4,62} \times 0,480 = 1,86 \text{ kg} \\ - \text{Beban hidup} & = 100 \times 0,480 = 48 \text{ kg} \\ & = 60,04 \text{ kg} \end{array}$$

B. Rencana Dimensi

$$\sigma_s \geq \frac{P / \cos \theta}{\frac{1}{4} \pi d^2}$$

$$1600 \geq \frac{660 / \cos 29^\circ}{0,25 \cdot 3,14 d^2}$$

$$d^2 \geq \frac{759,13}{1256}$$

$$d^2 \geq 0,78 \text{ cm}$$

Dambil diameter batang tarik besi beton  $\phi$  12 mm

## Dimensi Profil Batang

### Batang tarik

- Batang tarik tersusun dari baja siku ganda
- = gaya batang, Pembebanan tetap = 4400 kg (N)
- c. Panjang batang kritis = 3000 mm (Lk)

### Ketentuan

- Tegangan izin dasar, Pembebanan tetap = 1600 kg/cm<sup>2</sup>
- Tegangan izin tarik (75% x 5) Pembebanan tetap = 1200 kg/cm<sup>2</sup>
- ↳ Kelangsingan max  $\lambda_{max} = 240$
- d. Jari-jari inersia  $I_{min} > Lk / \lambda_{max} = \frac{3000}{240} = 1,25 \text{ cm}$
- e. Jumlah lubang  $< 15\% \times f_{netto}$
- f. Ditentukan Profil minimum batang Struktur JL 100.100.8

### Perhitungan

$$A_{netto} = \frac{N}{\sigma_a} = \frac{4400}{1200} = 3,67 \text{ cm}^2$$

$$A_{brutto} = \frac{A_{netto}}{0,85} = \frac{3,67}{0,85} = 4,31 \text{ cm}^2$$

Profil tabel diperoleh JL 100.100.8,  $f = 15,47$   $C_2, 2f = 30,94$   $4f, 1x = 3,07 > 2,00$  OK

### Kontrol tegangan

$$A_{netto} = 85\% = 2f = 26,30 \text{ cm}^2$$

$$\sigma = \frac{N}{A_{netto}} = \frac{4400}{26,30} = 167,6 \text{ cm}^2 < 1200 \text{ kg/cm}^2 \dots \text{OK}$$

## Dimensi Profil Batang

### Batang tarik

- a. Batang tarik tersusun dari baja siku ganda
- b. gaya batang, Pembebanan tetap = 4408 kg (N)
- c. Panjang batang kritis = 3000 mm (Lk)

### Ketentuan

- a. Tegangan izin dasar, Pembebanan tetap = 1600 kg/cm<sup>2</sup>
- b. Tegangan izin tarik (75% x S) Pembebanan tetap = 1200 kg/cm<sup>2</sup>
- c. Kelangsingan max  $\lambda_{max} = 240$
- d. Jari-jari inersia min  $> Lk / \lambda_{max} = \frac{3000}{240} = 1,25 \text{ cm}$
- e. Jumlah lubang  $< 15\% \times F_{netto}$
- f. Ditentukan Profil minimum batang Struktur JL 100.100.8

### Perhitungan

$$A_{netto} = \frac{N}{\sigma_a} = \frac{4408}{1200} = 3,67 \text{ cm}^2$$

$$A_{brutto} = \frac{A_{netto}}{85\%} = \frac{3,67}{0,85} = 4,31 \text{ cm}^2$$

Dari tabel diperoleh JL 100.100.8,  $F = 15,47$   $C_2, 2F = 30,94 - 48,1x = 3,07 > 2,00$  OK

### Kontrol tegangan

$$A_{netto} = 85\% = 2F = 26,30 \text{ cm}^2$$

$$\sigma = \frac{N}{A_{netto}} = \frac{4408}{26,30} = 167,6 \text{ cm}^2 < 1200 \text{ kg/cm}^2 \dots \text{OK}$$

Kontrol kelangsingannya

$$\lambda = \frac{L_k}{L_x} = \frac{3}{3,07} = 0,97$$

Batang terna yg menggunakan JL 100.100.8

$$t = 8 \text{ mm}$$

$$L_x = 292 \text{ cm}^4$$

$$k = 9 \text{ mm}$$

$$I_y = 600,83 \text{ cm}^4$$

$$r_1 = 10 \text{ mm}$$

$$L_x = 5,07 \text{ cm}$$

$$r_2 = 5 \text{ mm}$$

$$i_y = 4,44 \text{ cm}$$

$$T = 30,94 \text{ cm}^2$$

$$S_x = 40,28 \text{ cm}$$

$$W = 24,29 \text{ kg}$$

$$S_y = 58,26 \text{ cm}$$

## Batang tekan

- batang tekan tersusun dari baja siku ganda
- Gaya batang, pembebanan tetap = 11,330,25 kg (W)
- Panjang tekuk = 5,550 m (Lk)

### Ketentuan

a. tebal Plat buhul = 10 mm

b. tebal Plat kopel = 5 mm

c. alat sambung paku = 10 mm

- Tegangan izin dsr  $\bar{\sigma} = 1400 \text{ kg/cm}^2$

- Geser  $I = 1120 \text{ kg/cm}^2$

- Desak  $s_1 > 2d$   $\bar{\sigma}_{ds} = 2800 \text{ kg/cm}^2$

- Desak  $1.5d \leq s_1$   $\bar{\sigma}_{ds} = 2400 \text{ kg/cm}^2$

- Tegangan izin Pl  $\bar{\tau} = 812 \text{ kg/cm}^2$

d. Kelangsingan max  $\lambda_{max} = 200$

e. Jari-jari inersia  $i_{min} \geq Lk / \lambda_{max} = \frac{555}{200} = 2,78 \text{ cm}$

f. Profil minimum big struktur  $\angle L 100.100.8$

$$\lambda < 210$$

$$\lambda = \frac{Lk}{ix} = \frac{555}{3,07} = 180,78 > 110 \text{ kg/cm}^2 \dots \text{OK}$$

### Momen Inersia taksir

$$I_{taksir} = 1,21 \times 3596,35 \times 2,32^2$$

$$= 23,42 \text{ cm}^4 \text{ Suku Profil } 11,71 \text{ cm}^4$$

Kontrol tekuk

2 tnd tekuk 1 sbx

$$\chi = \frac{L_k}{i_x} = \frac{555}{3,07} = 180,78$$

Faktor tekuk

$$K_g = \chi + \sqrt{\frac{E}{0,70 \times 1200}} \times \chi_g = \frac{\chi_x}{\chi_g} = \frac{180,78}{171,30} = 1,06$$

$$= 3,14 \times \sqrt{\frac{2500000}{840}} \quad W_x = 1,61$$

$$\chi_g = 171,30$$

Tegangan tekuk

$$\sigma_x = W_x \frac{N}{A_{total}} = 1,61 \frac{-11,338,95}{30,94} = -590,04 < 1200 \text{ kg/cm}^2$$

2 tnd tekuk 1 sb-y

$$I_{y \text{ total}} = 2 (I_y + A (\frac{1}{2}a)^2)$$

$$n = 2e + y$$

$$= 3,36$$

$$I_y = 1239,58 \text{ cm}^4$$

$$I_y = \sqrt{\frac{I_{y \text{ total}}}{A_{tot}}} = \sqrt{\frac{1239,58}{30,94}} = 6,33 \text{ cm}$$

$$\chi = \frac{L_k}{I_y} = \frac{555}{6,33} = 87,68 \text{ cm}$$

$$\chi_{ly} = \sqrt{\chi_y^2 + \frac{m}{2} \chi_1^2}$$

dimana

UNIVERSITAS MEDAN AREA

$$\chi_y = 58,26$$



$$\chi_y = \frac{L_u/n}{i_{\min}} \leq 50$$

$$50 = \frac{555/n}{1,66}$$

$$n = \frac{555}{50} = 0,57 \text{ buah median plat kopel}$$

diambil = 10 buah

$$\chi_1 = \frac{L_u/n}{i_{\min}} = \frac{555/10}{1,16} = 43,50$$

$$\begin{aligned} \chi_{fy} &= \sqrt{\chi_y^2 + \frac{m}{2} \chi_1^2} \\ &= \sqrt{58,26^2 + \frac{m}{2} 4350^2} \\ &= 72,7 \end{aligned}$$

Faktor tahanan  $w = 0,85$

$$\sigma_x = w \frac{H}{A_{tot}} = 0,85 \frac{-11838,95}{30,94} = -311,51 < 1200 \text{ kg/cm}^2$$

Kontrol kestabilan

$$\chi_1 = 43,50 \rightarrow 1,2$$

$$\chi_1 = 43,50$$

$$\chi_1 \geq 1,2 \chi_1$$

$$\chi_{1y} = 1,2 \chi_1$$

$$180,78 > 30$$

$$72,71 > 30,00$$

## Rencana Plat Kopel

$$\frac{I_p}{a} \leq 10 \frac{I_1}{L_1} \quad \text{atau} \quad I_p \leq 10 a \frac{I_1}{L_1}$$

Dimana momen inersia plat kopel adalah

$$I_p = 1/12 t h^3$$

digunakan plat kopel dengan dimensi

$$\text{tinggi } t = 10 \text{ mm}$$

$$\text{tebal } h = 100 \text{ mm}$$

$$\begin{aligned} \text{Sehingga } I_1 = I_n = I_{\min} &= 83333,2 \text{ mm}^4 \\ &= 83,3 \text{ cm}^4 \end{aligned}$$

$$\text{dik : } a = 2,14$$

$$L_1 = 21 \text{ cm}$$

$$\text{maka : } \frac{83}{7} \leq 10 \frac{292}{21}$$

$$12 \leq 139 \dots \text{ OK}$$

## Rencana Paku

$$\text{Paku diameter} = 10 \text{ mm}$$

$$S1 = 2d = 20 \text{ mm}$$

$$S1 \text{ diambil} = 15 \text{ mm}$$

$$C = S = 3d = 30 \text{ mm}$$

$$C = S1 \text{ diambil} = 30 \text{ mm}$$

$$S2 = W = 35 \text{ mm}$$

$$b = 2S2 + y = 70 \text{ mm}$$

$$h = 2 S1 \text{ diambil} + S = 60 \text{ mm}$$

## Kekuatan Paku

$$S1 > 2d \text{ } \sigma \text{ } d_s = 2800 \text{ kg/cm}^2$$

$$P_{D1} = 2 \cdot \frac{1}{4} \pi d^2 L = 860 \text{ kg/cm}^2$$

$$P_{d1} = t d \sigma d_s = 784 \text{ kg/cm}^2$$

## Rencana Paku

$$\text{Paku diameter} = 10 \text{ mm}$$

$$S_1 = 2d = 20 \text{ mm}$$

$$S_1 \text{ diambil} = 25 \text{ mm}$$

$$C = S = 3d = 30 \text{ mm}$$

$$C = S_1 \text{ diambil} = 30 \text{ mm}$$

$$S_2 = w = 25 \text{ mm}$$

$$b = 2S_2 + y = 70 \text{ mm}$$

$$h = 2 S_1 \text{ diambil} + S = 60 \text{ mm}$$

## Kekuatan Paku

$$S_1 > 2d \cdot \sigma_{ds} = 2800 \text{ kg/cm}^2$$

$$P_w = 2 \cdot \frac{1}{4} \pi d^2 T = 860 \text{ kg/cm}^2$$

$$P_{ds} = f_d \cdot \sigma_{ds} = 784 \text{ kg/cm}^2$$

## Perhitungan Jumlah baut Plat buhul

### 1. Titik buhul - A

#### 1.1 Profil S1

$$N = 4400 \text{ ug}$$

$$Pd_s = 784 \text{ ug/cm}^2$$

$$Pgs = 860 \text{ ug/cm}^2$$

$$\text{Jumlah Paku} = \frac{N}{Pgs} = \frac{4400}{860} = 5,13 = 6 \text{ buah}$$

#### 1.2 profil S6

$$N = 5066,65$$

$$\text{Jumlah Paku} = \frac{N}{Pd_s} = \frac{5066,65}{784} = 6,46 = 7 \text{ buah}$$

## 2 Titik buhul C

### 2.1 Profil S1 dan S2

$$N = 4400 \text{ ug}$$

$$\text{Jumlah Paku} = \frac{N}{Pgs} = \frac{4400}{860} = 5,13 = 6 \text{ buah}$$

### 2.2 Profil S7

$$N = 0 \text{ ug}$$

### 3 Titik bukul D

#### 3.1 Profil S3

$$N = 3261,91 \text{ kg}$$

$$\text{jumlah paku} = \frac{N}{Pds} = \frac{3261,91}{784} = 4,16 \text{ bh} = 5 \text{ buah}$$

#### 3.2 profil S8

$$N = 1736,49$$

$$\text{jumlah paku} = \frac{N}{Pds} = \frac{1736,49}{860} = 2,02 = 3 \text{ buah}$$

### 4 Titik bukul H

#### 4.1 Profil se

$$N = 1736,49 \text{ kg}$$

$$\text{jumlah paku} = \frac{N}{Pds} = \frac{1736,49}{784} = 2,21 = 3 \text{ buah}$$

#### 4.2 Profil S12

$$N = 6391,88 \text{ kg}$$

$$\text{jumlah paku} = \frac{N}{Pds} = \frac{6391,88}{784} = 8,15 = 9 \text{ buah}$$

#### 4.3 Profil S15

$$N = 5832,27 \text{ kg}$$

$$\text{jumlah paku} = \frac{N}{Pds} = \frac{5832,27}{784} = 7,44 = 8 \text{ buah}$$

#### 4.4. Profil S16

$$N = 6145,08 \text{ kg}$$

$$\text{jumlah paku} = \frac{N}{Pds} = \frac{6145,08}{784} = 7,84 = 8 \text{ buah}$$

## 5. Titik buhul G

### 5.1 Profil S6

$$N = 5067 \text{ kg}$$

$$\text{Jumlah paku} = \frac{N}{Pds} = \frac{5066,65}{784} = 6,46 = 7 \text{ buah}$$

### 5.2 Profil S7

$$N = 0 \text{ kg}$$

### 5.3 Profil S7

$$N = 6391,88 \text{ kg}$$

$$\text{Jumlah paku} = \frac{N}{Pgs} = \frac{6391,88}{860} = 7,43 = 8 \text{ buah}$$

### 5.4 Profil S14

$$N = 4158,3 \text{ kg}$$

$$\text{Jumlah paku} = \frac{N}{Pds} = 5,3 = 6 \text{ buah}$$

## 6. Titik buhul K

### 6.1 Profil S14

$$N = 4158,3 \text{ kg}$$

$$\text{Jumlah paku} = \frac{N}{Pds} = \frac{4158,3}{784} = 5,3 = 6 \text{ buah}$$

### 6.2 Profil S15

$$N = 5852,27 \text{ kg}$$

$$\text{Jumlah paku} = \frac{N}{Pgs} = \frac{5852,27}{860} = 6,78 = 7 \text{ buah}$$

### 6.3. Profil S 20

$$N = -3936,69 \text{ kg}$$

$$\text{Jumlah Paku} = \frac{N}{\text{Pds}} = \frac{3936,69}{784} = 5,02 = 6 \text{ buah}$$

### 64. Profil D1

$$N = -508,98$$

$$\text{Jumlah Paku} = \frac{N}{\text{Pds}} = \frac{508,98}{784} = 0,65 = 1 \text{ buah}$$

### 7. Titik bukul N

#### 71. titik bukul Profil D1

$$N = -508,98 \text{ kg}$$

$$\text{Jumlah Paku} = \frac{N}{\text{Pgs}} = \frac{508,98}{784} = 0,65 = 1 \text{ buah}$$

#### 72 Profil D3

$$N = -1262,90 \text{ kg}$$

$$\text{Jumlah Paku} = \frac{N}{\text{Pgs}} = \frac{1262,90}{860} = 1,47 = 2 \text{ buah}$$

#### 7.3 Profil D6

$$N = -1768,06 \text{ kg}$$

$$\text{Jumlah Paku} = \frac{N}{\text{Pds}} = \frac{1768,06}{784} = 2,26 = 3 \text{ buah}$$



8 Titik buhul P

8.1 Profil D6

$$N = -1768,06 \text{ ug}$$

$$\text{Jumlah Paku} = \frac{N}{Pds} = \frac{1768,06}{784} = 2,26 = 3 \text{ buah}$$

8.2. Profil D5

$$N = -412,04 \text{ ug}$$

$$\text{Jumlah Paku} = \frac{N}{Pds} = \frac{412,04}{784} = 0,52 = 1 \text{ buah}$$

8.3 Profil D7

$$N = -1768,06 \text{ ug}$$

$$\text{Jumlah paku} = \frac{N}{Pds} = \frac{1768,06}{784} = 2,26 = 3 \text{ buah}$$

9 Titik buhul M

9.1 Profil S16

$$N = -6145 \text{ ug}$$

$$\text{Jumlah Paku} = \frac{N}{Pds} = \frac{6145,08}{784} = 7,84 = 8 \text{ buah}$$

9.2. Profil S17

$$N = -6145 \text{ ug}$$

$$\text{Jumlah Paku} = \frac{N}{Pds} = \frac{6145,08}{784} = 7,84 = 8 \text{ buah}$$

9.3 Profil S20

$$N = -3936,69 \text{ kg}$$

$$\text{Jumlah Paku} = \frac{N}{Pds} = \frac{3936,69}{784} = 5,02 = 6 \text{ buah}$$

9.4 Profil S21

$$N = -3936,69 \text{ kg}$$

$$\text{Jumlah Paku} = \frac{N}{Pds} = \frac{3936,69}{784} = 5,02 = 6 \text{ buah}$$

9.5 Profil D3

$$N = 1262,90 \text{ kg}$$

$$\text{Jumlah Paku} = \frac{N}{Pgs} = \frac{1262,90}{860} = 1,47 = 2 \text{ buah}$$

9.6 = Profil D4

$$N = 1262,90 \text{ kg}$$

$$\text{Jumlah Paku} = \frac{N}{Pds} = \frac{1262,90}{860} = 1,46 = 2 \text{ buah}$$

9.7 Profil D5

$$N = -412,04 \text{ kg}$$

$$\text{Jumlah Paku} = \frac{N}{Pds} = \frac{412,04}{784} = 0,53 = 1 \text{ buah}$$

-  
0  
-  
0  
-

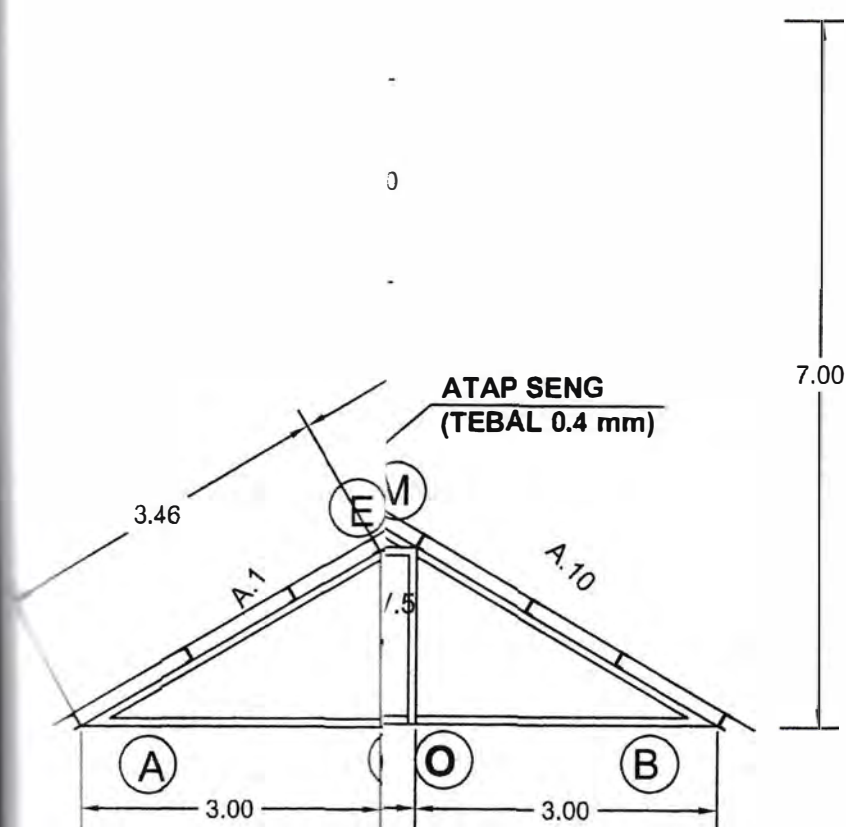

## ANG TARIK

**GORDING ATAP  
BESI C 100.50.3,2**

**Baut Besi  
(Pengikat Gording)**

**Atap Seng  
(Tebal 0,4 mm)**

